

Clarion®

Owner's manual & Installation manual
Mode d'emploi et manuel d'installation
Manual de instrucciones y de instalación

VRX755VD

AM/FM DVD VIDEO / VIDEO CD / CD / MP3
PLAYER / CD CHANGER CONTROLLER WITH 7"
LC DISPLAY

CONTRÔLEUR DE RADIO AM/FM/LECTEUR DVD
VIDÉO /CD VIDÉO/CD/MP3/CHANGEUR CD AVEC
AFFICHEUR À CRISTAUX LIQUIDES DE 7
POUCES!

CONTROLADOR DE RADIO DE AM/FM,
REPRODUCTOR DE DISCOS DVD/VIDEODISCOS
CD/CD/MP3/CAMBIADOR DE DISCOS CD CON
VISUALIZADOR DE CRISTAL LÍQUIDO DE 7"

ProAudio **CaNET**  

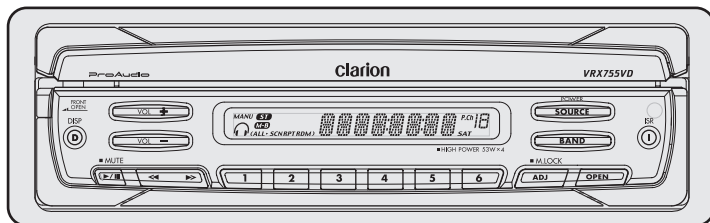

MP3
ID3 TAG

dts®
DIGITAL OUT

DOLBY®
DIGITAL

COMPACT
disc
DIGITAL VIDEO

COMPACT
disc
DIGITAL AUDIO
TEXT

SIRIUS
READY

Thank you for purchasing the Clarion **VRX755VD**.

* This owner's manual is for the **VRX755VD**.

* Please read this owner's manual in its entirety before operating this equipment.

* After reading this manual, be sure to keep it in a handy place (e.g., glove compartment).

* Check the contents of the enclosed warranty card and keep it carefully with this manual.

* This manual includes the operating procedures of the CD changer, DVD changer, TV tuner, SIRIUS, iPod control, 2-ZONE control, 5.1ch surround decoder. The CD changer, TV tuner, 5.1ch surround decoder and DVD Changer have their own manuals, but no explanations for operating them are described.

Contents

1. FEATURES	2
2. PRECAUTIONS	3
3. CONTROLS	5
4. NOMENCLATURE	6
5. DISPLAY	8
6. OUTLINE OF BUTTON AND TOUCHKEY OPERATION	10
7. REMOTE CONTROL	16
8. DCP	19
9. CAUTIONS ON HANDLING	20
10. DVD VIDEO SYSTEM	21
11. OPERATIONS	23
Basic Operations	23
Radio Operations	31
DVD Video Player Operations	33
iPod Operations	45
VISUAL Operations	47
CD Changer Operations	47
DVD Changer Operations	50
TV Operations	50
SIRIUS Operations	52
Other Functions	55
5.1 ch Surround Decoder Operations	57
12. IN CASE OF DIFFICULTY	60
13. ERROR DISPLAYS	62
14. SPECIFICATIONS	63
<i>Installation and wire connection manual</i>	<i>65</i>

1. FEATURES

- Fully-Motorized 7" Widescreen LCD
- Touch Panel Control
- DVD Video/CD-DA/MP3/Video CD Play Capability
- RCA 6-Channel Output
- Built-in 53W × 4 Amplifier
- CeNET with Balanced Audio Line Transmission and Dynamic Noise Canceling
- Multi Angle, Multi Story, Slow Motion Capability
- ID3 Tag Capability
- CD TEXT Capable
- CD-R/CD-RW Compatible
- 5.1 Channel Decoder for DTS and Dolby Digital Capability
- Optical Digital Output
- 2-ZONE Control
- iPod® Control

2. PRECAUTIONS

⚠ WARNING

For your safety, the driver should not watch the TV or operate the controls while driving. Please note that watching and operating the TV while driving are prohibited by law in some countries. Also, while driving, keep the volume to a level at which external sounds can be heard.

1. When the inside of the car is very cold and the player is used soon after switching on the heater, moisture may form on the disc (DVD/CD) or the optical parts of the player and proper playback may not be possible. If moisture forms on the disc (DVD/CD), wipe it off with a soft cloth. If moisture forms on the optical parts of the player, do not use the player for about one hour. The condensation will disappear naturally allowing normal operation.

2. Driving on extremely bumpy roads which cause severe vibration may cause the sound to skip.

3. This unit uses a precision mechanism. Even in the event that trouble arises, never open the case, disassemble the unit, or lubricate the rotating parts.

4. TV broadcast reception

When receiving the TV broadcasts, the strength of the signals changes since the car is moving, so in some cases it may not be possible to receive clear pictures.

- TV signals are strongly linear, so reception is affected by buildings, mountains and other obstacles.
 - Such external factors such as electric train lines, a high voltage lines, and signal devices may disturb the picture or cause noise.
- * If the reception is poor, switch to a station with good reception.

5. This equipment has been tested and found to comply with the limits for a Class B digital device, pursuant to Part 15 of the FCC Rules. These limits are designed to provide reasonable protection against harmful interference in a residential installation. This equipment generates, uses, and can radiate radio frequency energy and, if not installed and used in accordance with the instructions,

may cause harmful interference to radio communications. However, there is no guarantee that interference will not occur in a particular installation. If this equipment does cause harmful interference to radio or television reception, which can be determined by turning the equipment off and on, the user is encouraged to consult the dealer or an experienced radio/TV technician for help.

INFORMATION FOR USERS:
CHANGES OR MODIFICATIONS TO THIS PRODUCT NOT APPROVED BY THE MANUFACTURER WILL VOID THE WARRANTY AND WILL VIOLATE FCC APPROVAL.

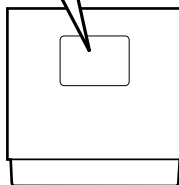
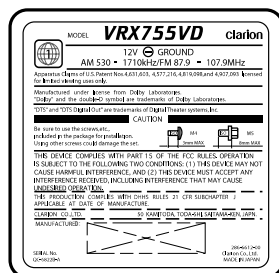

Handling Discs

Handling

- New discs may have some roughness around the edges. If such discs are used, the player may not work or the sound may skip. Use a ball-point pen or the like to remove any roughness from the edge of the disc.

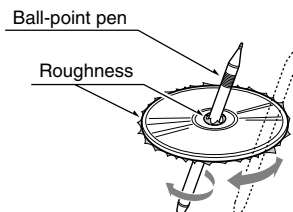

- Never stick labels on the surface of the disc or mark the surface with a pencil or pen.
- Never play a disc with any cellophane tape or other glue on it or with peeling off marks. If you try to play such a disc, you may not be able to get it back out of the DVD player or it may damage the DVD player.
- Do not use discs that have large scratches, are misshapen, cracked, etc. Use of such discs may cause misoperation or damage.
- To remove a disc from its storage case, press down on the center of the case and lift the disc out, holding it carefully by the edges.
- Do not use commercially available disc protection sheets or discs equipped with stabilizers, etc. These may damage the disc or cause breakdown of the internal mechanism.

Storage

- Do not expose discs to direct sunlight or any heat source.
- Do not expose discs to excess humidity or dust.
- Do not expose discs to direct heat from heaters.

Cleaning

- To remove fingermarks and dust, use a soft cloth and wipe in a straight line from the center of the disc to the circumference.
- Do not use any solvents, such as commercially available cleaners, anti-static spray, or thinner to clean discs.
- After using special disc cleaner, let the disc dry off well before playing it.

On Discs

- Exercise a good precaution when loading a disc with the panel open.
- Never turn off the power and remove the unit from the car with a disc loaded.

⚠ CAUTION

With the screen open, a driver may not see the disc insertion slot. For your safety, insert a disc with the screen closed.

Even when the screen is closed, however, the recessed disc slot may be difficult for a driver to see, care is needed whenever inserting discs.

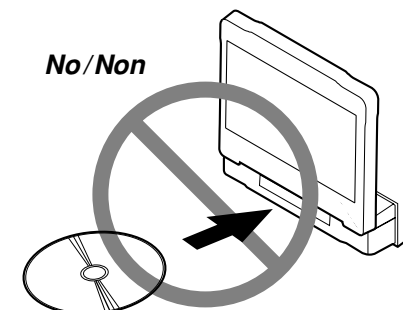

Be sure to unfold and read the next page.
Veuillez déplier et vous référer à la page suivante.
Cerciórese de desplegar y de leer la página siguiente.

3. CONTROLS / COMMANDES / CONTROLES

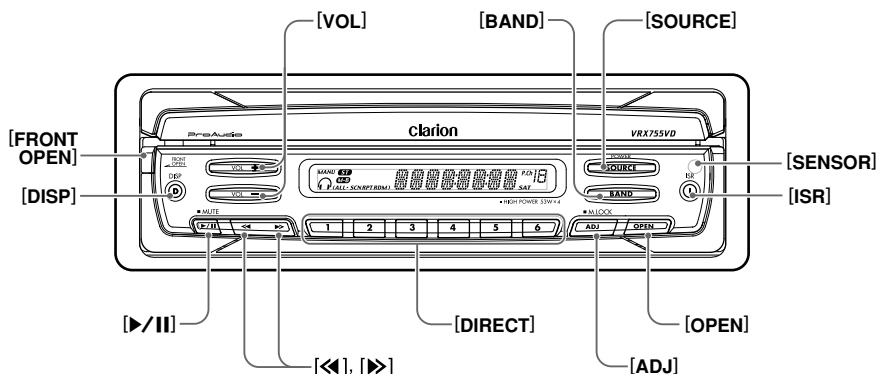

With the Front panel open / Avec le panneau avant ouvert / Con el panel frontal abierto

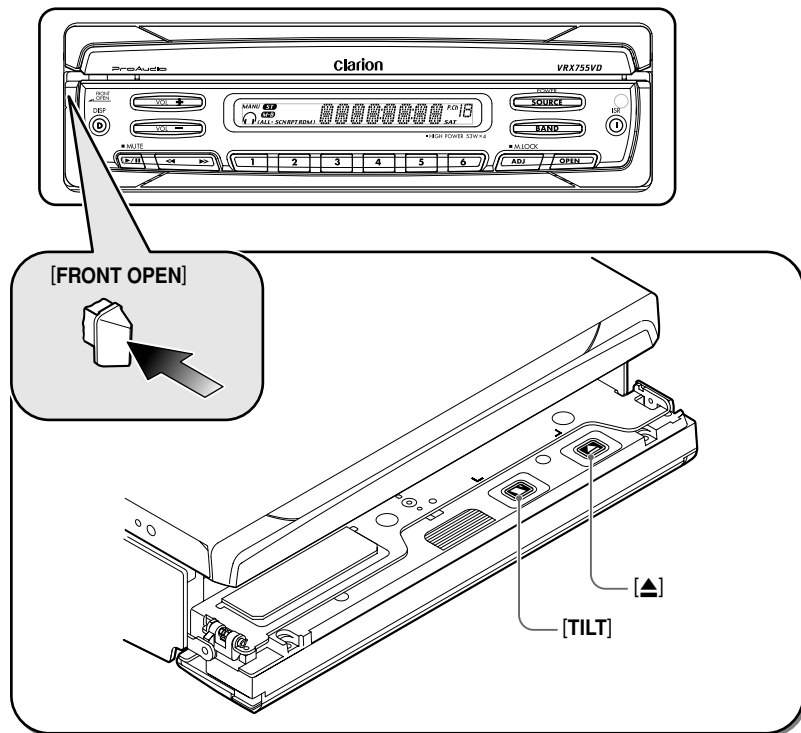

Note: Be sure to unfold this page and refer to the front diagrams as you read each chapter.
Remarque: Veuillez déplier cette page et vous référer aux schémas quand vous lisez chaque chapitre.
Nota: Cuando lea los capítulos, despliegue esta página y consulte los diagramas.

4. NOMENCLATURE

Names of Buttons

Note:

• Be sure to read this chapter referring to the front diagrams of chapter "3. CONTROLS" on page 5 (unfold).

[VOL] button

• Use this button to increase/decrease the volume.

[BAND] button

• Press this button to switch the receiving bands for radio/SIRIUS/TV mode, etc. Press and hold this button for 1 second or longer to switch the SEEK/MANUAL tuning modes.
 • Use this button to move to the first track on a disc in the DVD video mode.
 • Use this button to switch to the next disc in the changer mode.

[SOURCE] button

• Press this button to turn on the power. Press and hold this button for 1 second or longer to turn off the power.
 • Press this button to switch the modes such as radio.

[SENSOR]

• Remote control infrared sensor.

[ISR] button

• Use this button to enter the ISR (Instant station recall) standby mode.
 • Press and hold this button for 2 seconds or longer to store the current station into ISR memory in the radio mode.
 * ISR is disabled when 2-ZONE is ON.

[OPEN] button

• Use this button to open/close the liquid crystal panel.
 • Press and hold this button for about 2 seconds or longer so that the liquid crystal panel is positioned horizontally when the liquid crystal panel is open (Air Conditioner Operation mode).

[ADJ] button

• Shows the ADJUST mode menu to change the settings when the liquid crystal panel is open.
 • Press and hold this button for 1 second or longer, the liquid crystal panel can be switched to a composite screen to lock the monitor. (To enable this function, go to the GENERAL menu (within the ADJUST mode menu), and use the [CONNECT] key to select "NAVI" or "OTHERS").

[DIRECT] buttons

• Use this button to select a preset channel in the radio/SIRIUS/TV mode.
 • Use this button to select a disc in the changer mode.
 • Press and hold one of the [DIRECT] buttons for 2 seconds or longer to store the current station into preset memory.

[◀], [▶] buttons

• Use this button to tune to a station in the radio/SIRIUS/TV mode.
 • Use this button to select a track in the CD, Video CD, MP3, iPod and CD changer mode.
 • Use this button to select a chapter in the DVD video and DVD changer mode.

[▶/||] button

• Press this button to enter the play pause mode in the DVD video mode, iPod mode and changer mode. Press the button again to resume playback.
 • Press and hold this button for 1 second or longer to mute the sound in the DVD video mode, iPod mode and changer mode.
 • Press this button to mute the sound in the radio/SIRIUS/TV/VISUAL mode.

[DISP] button

• Use this button to switch the indications such as play status on the information panel.

[FRONT OPEN] button

• Use this button to open the Front panel.

When the Front panel open

[TILT] button

- Use this button to adjust the angle of the liquid crystal panel in 5 steps when the liquid crystal panel is open.
- When the panel is closed, holding this button depressed for 2 seconds or longer will enable the panel calibration function.

[▲] button

- Use this button to eject a disc.

5. DISPLAY

The Color LCD Display and the Information Panel on the main unit show the following displays, providing information about the mode and functions operated.

Information Panel

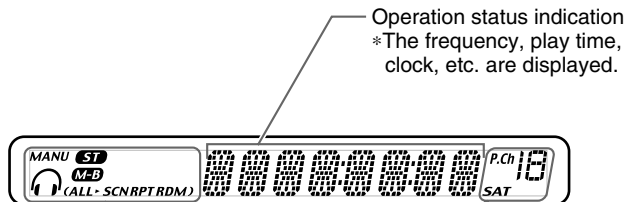

Operation status indication
*The frequency, play time, clock, etc. are displayed.

MANU: Manual indication
ST: Stereo indication
M-B: MAGNA BASS-EX indication
ALL: ALL indication
SCN: Scan indication
RPT: Repeat indication
RDM: Random indication
 : 2-ZONE indication

P.Ch 18
 : Preset channel indication
 Disc number indication
 *The disc numbers corresponding to the discs in the DVD or CD changer light.
SAT: SIRIUS indication

Mode name

- Radio mode : **FM1 98.1MHz Pch 1** (band/frequency/preset No.)
- SIRIUS mode : **SR1 100ch Pch 1** (band/channel/preset No.)
- DVD changer mode: **D2 T02 C002 01:08:20**
(disc No./title No./chapter No./ playback time)
- DVD video mode : **T01 C003 00:08:20** (title No./chapter No./playback time)
- Video CD mode : **T01 00:01:18** (track No./playback time)
- MP-3 mode : **F001 T001 00:04:07** (folderNo./track No./playback time)
- CD mode : **T 02 04 : 07** (track No./playback time)
- CD changer mode : **D2 T02 00 : 45** (disc No./track No./playback time)
- TV mode : **TV1 28CH Pch 1** (band/channel/preset No.)
- VISUAL mode : No display



Clock time

2-ZONE indication
Icon color indicates ON/OFF.
OFF: blue
ON: green

Displays control keys corresponding to play mode.

Example for radio mode:

SRCH : Input numbers to tune specific broadcast frequencies.

BAND : Switch reception band

LIST : Display preset memory station list.

MANU ST M-B EX : Tune stations

- **MANU** : Seek/Manual indication
- **ST** : Stereo indication
- **M-B EX** : MAGNA BASS-EX indication
- When the 5.1ch surround decoder (DVH940) is connected, the signal format of the digital input signal (for example, "Dolby D 3/2+LFE") is displayed.

- Radio/TV mode : **USER WEST COAST** (user title)
- SIRIUS mode : **CH.NAME CH801** (channel name)
: **CATEGORY ROCK** (category)
: **TITLE WALK THIS WAY** (title)
: **ARTIST CH801** (artist)
: **R TEXT RADIO TEXT** (radio text)
- CD mode/CD changer mode : **USER SHINE** (user title)
- CD TEXT in CD mode/CD changer mode
: **DISC SHINE** (disc title)
: **TRACK Time has come** (track title)
: **ARTIST Time has come** (artist)

6. OUTLINE OF BUTTON AND TOUCHKEY OPERATION

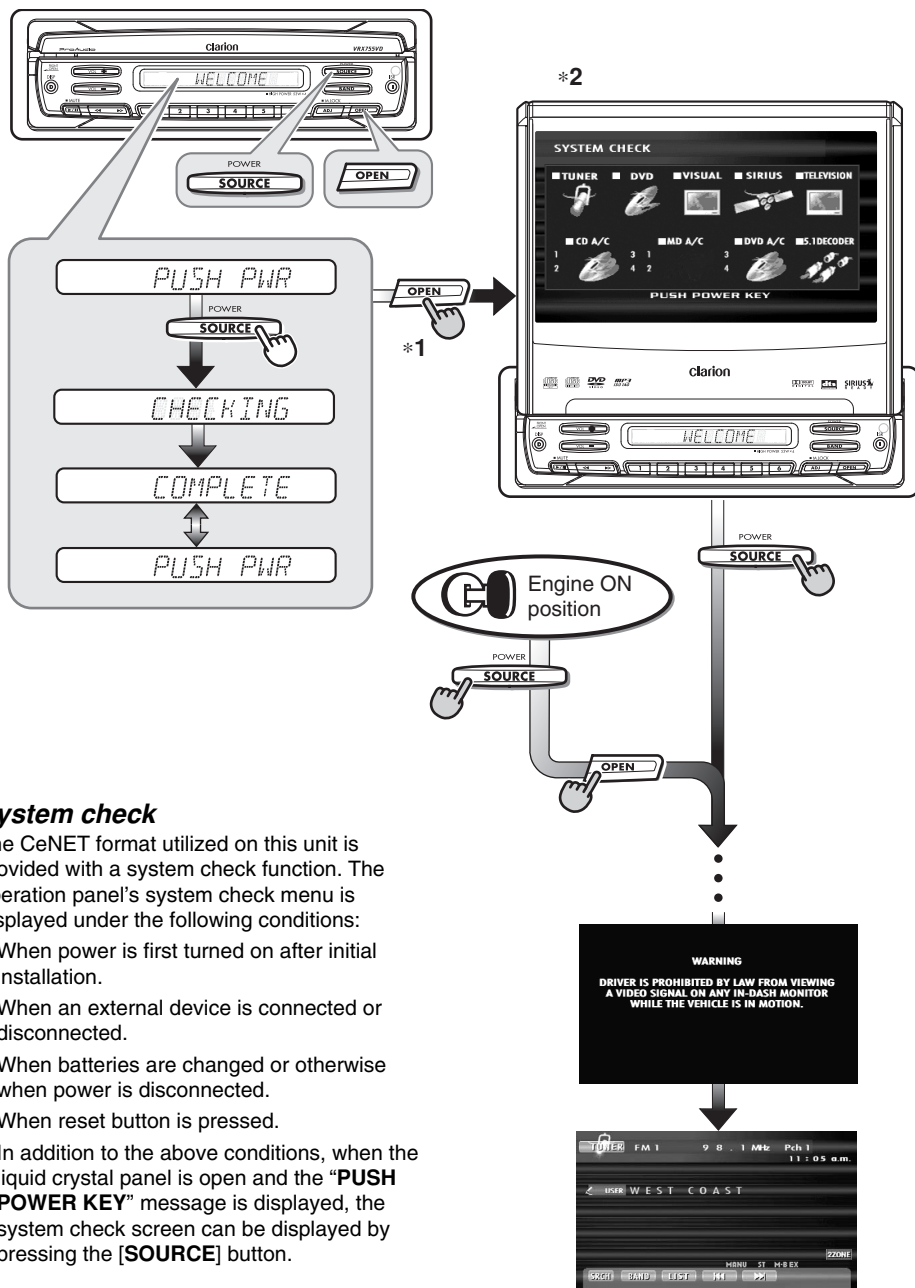

(Radio mode screen)

(Next page) →

(List screen)**(KEY PAD screen)**

*4

**(Title input screen)**

*5

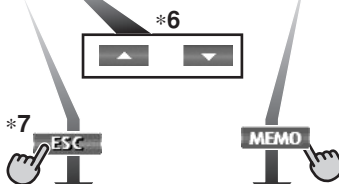

*7

**Notes:**

- *1: The operation button is [OPEN] button in the description of operation per mode.
- *2: External equipment not connected with CeNET is not displayed.
- *3: The operation key is [SRCH] key in the description of operation per mode.
- *4: This shows a KEY PAD selection example in the radio mode when 107.9 MHz is selected.
- *5: Touch the [RTN] key to return to the previous screen.
- *6: Touch the [▼] key to go to the next menu. Touch the [▲] key to return to the previous menu.
- *7: Touch the [ESC] key to return to the main screen.

(Radio mode screen)



(SOURCE menu)



*8



*9



*11 (DVD mode screen)



*10



MENU



SUB



SETUP



(SUB menu)



P.TIME

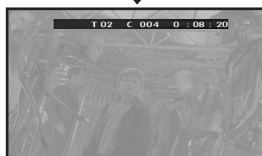

*12

**Notes:**

- *8: The SOURCE menu screen displays icons for components connected to the main unit. The icons serve as touch keys for selecting play modes.
- *9: Pressing the [SOURCE] button changes to the following play modes.
- *10: Screen during DVD mode when automobile is moving.
- *11: When displaying images in DVD mode, touching the screen surface will cause the menu screen to be displayed.
- *12: When the playback status has been displayed by pressing the [P.TIME] key, the display can be canceled by touching the screen.

(Next page) →

(DVD SETUP menu)

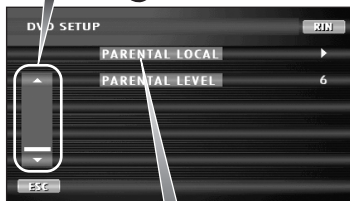

PARENTAL LEVEL

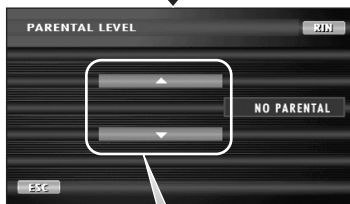

RTN



(ADJUST mode menu)

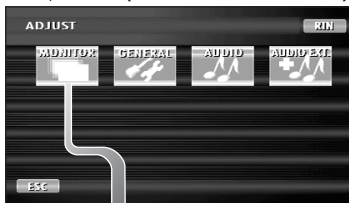

(MONITOR menu)



MONI ADJ



HUE (BRIGHT , COLOR)



RTN



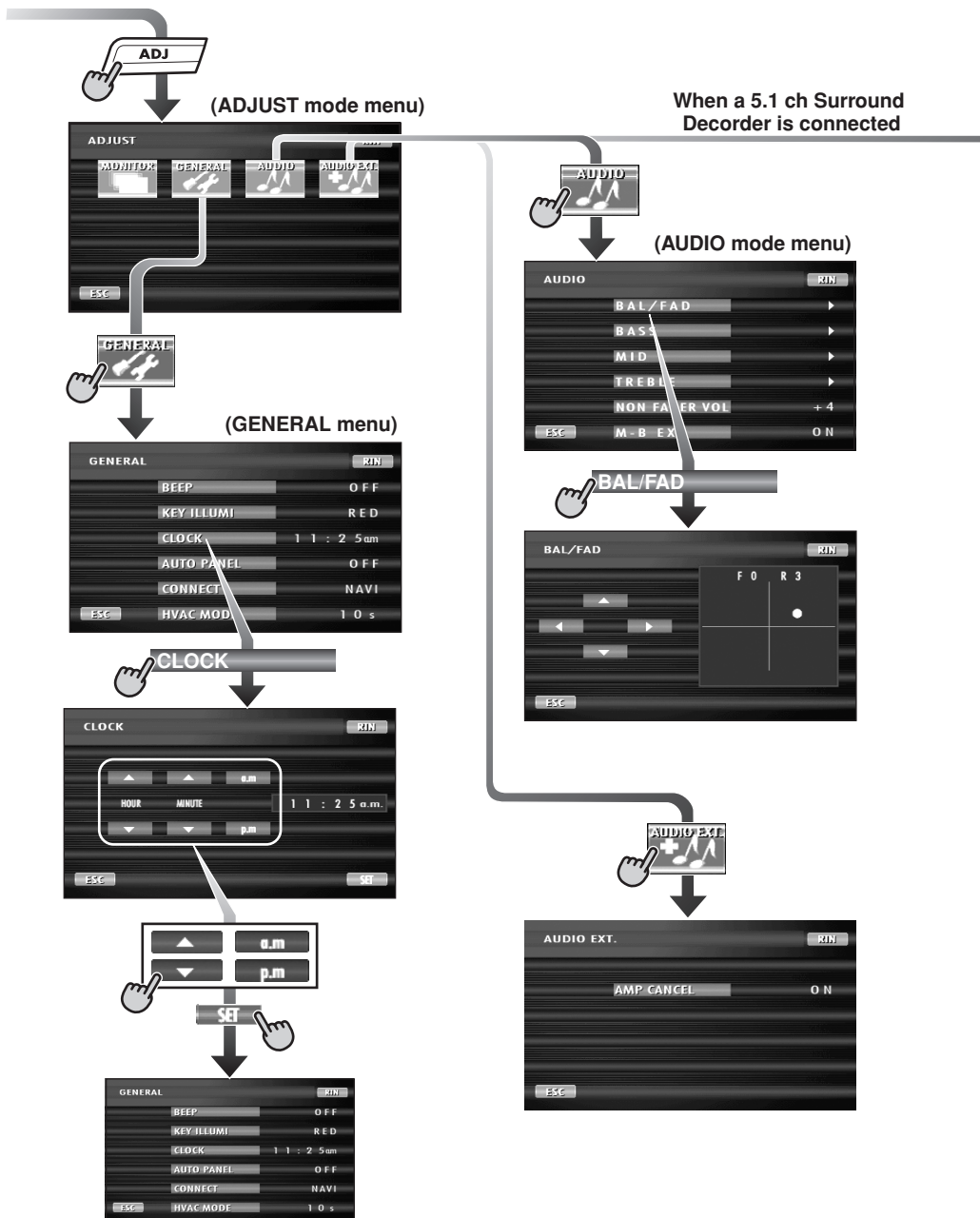

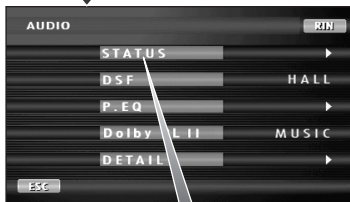

7. REMOTE CONTROL

Remote control unit

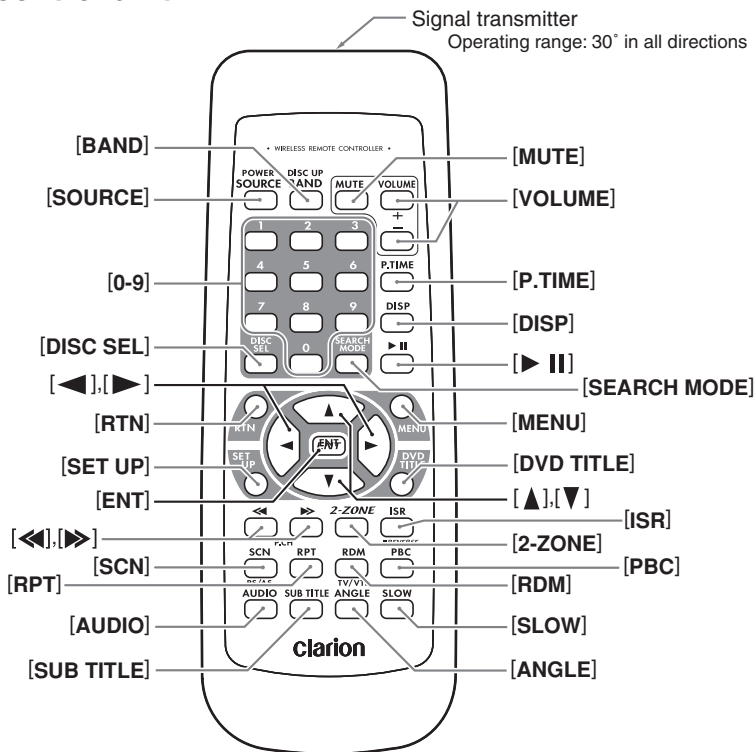

Inserting the Batteries

1. Turn the remote control unit over, then slide the rear cover in the direction of the arrow.
2. Insert the AA (SUM-3, IECR-6/1.5V) batteries that came with the remote control unit facing in the directions shown in the figure, then close the rear cover.

Notes:

Using batteries improperly can cause them to explode. Take note of the following points:

- When replacing batteries, replace both batteries with new ones.
- Do not short-circuit, disassemble or heat batteries.
- Do not dispose of batteries into fire or flames.
- Dispose of spent batteries properly.

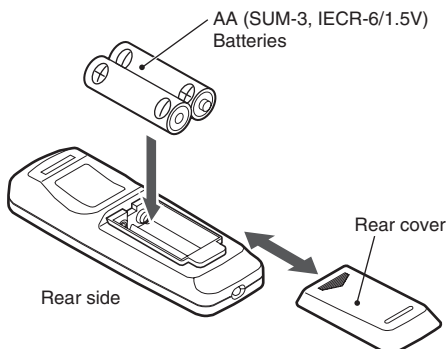

Functions of Remote Control Unit Buttons

This remote control unit enables SUB zone when 2-ZONE function is ON. The following descriptions of functions are divided respectively into those cases when 2-ZONE is ON and OFF.

When 2-ZONE function is OFF:

● Shared modes

[SOURCE] button

- Press and hold this button for 1 second or longer to turn on or off the power. Power on/off, switches among radio, TV, etc.

[VOLUME] button

- Increases and decreases volume.

[MUTE] button

- Turns mute on and off.

[ISR] button

- Recall ISR radio station in memory.
- Press and hold for 2 seconds or longer: Store current station into ISR memory (radio mode only).
- * ISR is disabled when 2-ZONE is ON.

[DISP] button

- Press to change display on information panel (MAIN → SUB → Clock Time)

[2-ZONE] button

- Press and hold this button for 1 second or longer to turn on the 2-ZONE, press again to turn 2-ZONE off.

● Radio/TV/SIRIUS mode

[BAND] button

- Switches reception band.

[0 - 9] button

- Use in the KEY PAD operation screen to set the radio frequency and TV/SIRIUS channels.

[DISC SEL] button

- Press to display the P.CH SELECT screen.

[SEARCH MODE] button

- Press to display the KEY PAD operation screen.

[ENT] button

- Press to confirm numerics entered in the KEY PAD operation screen.

[◀], [▶] buttons

- Press to select the next higher or lower preset channel in radio and TV/SIRIUS mode.

[SCAN] button

- Press to perform preset scans in the radio, TV and SIRIUS modes.
- Press and hold for 2 seconds or longer to perform the auto store operation in the radio and TV modes.

[RDM] button

- Press to switch between TV mode and VTR mode.

● DVD player mode

[BAND] button

- Press to return to the first chapter in DVD video mode.
- Press to return to the first track in CD/MP-3 mode or video CD mode with the PBC function turned off.

[P.TIME] button

- Press to turn on and off the playtime display in the DVD video and video CD mode.

[▶] [⏸] button

- Press to play or pause video and audio media.
- Press and hold this button for 1 second or longer to stop video playback in DVD video.

[0 - 9] buttons

- Press to enter DVD video chapters in the KEY PAD screen.
- Press to set the track number of the Video CD with the PBC function turned off, CD track number or MP-3 track number in the KEY PAD screen.

[SEARCH MODE] button

- Press to display the KEY PAD operation screen.

[RTN] button

- Press to switch the screen display while the MENU screen is being displayed. However, it may occur that this button operation does not work on some discs.

[MENU] button

- Press to display menu stored on video disc. (Disabled when 2-ZONE is ON, and when liquid crystal panel is open.)

[SET UP] button

- Press to display the menu for setting audio features during DVD video playback.
- Press to show the DVD SETUP menu.
- * If you want to select a menu after the SETUP menu is displayed, touch the operation keys on the menu screen.

[DVD TITLE] button

- Press to display the title screen on DVD video discs. Some discs do not display the title screen.

[▲], [▼], [◀], [▶] buttons

- Press to select menus and other items during DVD video/MP-3 playback.

[ENT] button

- Press to confirm numerics entered in the KEY PAD operation screen.

[◀], [▶] buttons

- Press to select the next higher or lower chapter number in DVD video mode.
- Press to select the next higher or lower track numbers in CD/MP-3 mode or video CD mode with the PBC function turned off.
- Hold down to perform fast-forward and fast-backward.

Functions of Remote Control Unit Buttons

[SCAN] button

- Press to perform chapter scans in DVD video mode and track scans in CD mode. Press to perform track scan and hold down to perform folder in MP-3 mode.

[RPT] button

- Press to perform chapter repeat in DVD video mode and track repeat in CD mode. In the MP-3 mode, press to perform track repeat and hold down to perform folder repeat.

[RDM] button

- Press to play tracks at random in CD mode. In the MP-3 mode, press to play tracks at random and hold down to play folders at random.

[PBC] button

- Press to turn on and off the PBC function in video CD mode.

[AUDIO] button

- Press to switch on the AUDIO function in DVD video and video CD modes.

[SUB TITLE] button

- Press to display subtitles in DVD video mode.

[ANGLE] button

- Press to turn the ANGLE function on and off in DVD video mode. (This button is available only on multiple angles DVDs.)

[SLOW] button

- Press to perform slow playback in DVD video or video CD mode.

● CD changer mode

[BAND] button

- Press to switch discs.

[DISC SEL] button

- Used to change the disc.

▶ [] button

- Press to play and pause the media.

[0 - 9] buttons

- Press to enter track numbers in the KEY PAD screen.

[SEARCH MODE] button

- Press to display the KEY PAD operation screen.

[◀], [▶] buttons

- Press to select the next higher or lower playback track.
- Hold down to perform fast-forward and fast-backward.

[SCAN] button

- Press to perform track scan and hold down to perform disc scan.

[RPT] button

- Press to perform track repeat and hold down to perform disc repeat.

[RDM] button

- Press to play tracks at random and hold down to play folders at random.

● DVD changer mode

[BAND] button

- Press to switch discs.

[DISC SEL] button

- Used to change the disc.

* *Other button operations in this mode are the same as those in DVD player mode.*

When 2-ZONE function is ON:

SUB zone operations are supported, but button functions are limited as follows:

● Shared modes

[SOURCE] button

- Turns power ON/OFF
- When power is ON, switches between DVD mode and VISUAL mode. When iPod is connected, however, this button is disabled since mode is limited to DVD.

[VOLUME] button

- Controls sound volume for MAIN zone source.

[MUTE] button

- Controls audio mute function for MAIN zone source.

[ISR] button

Not supported.

[DISP] button

- Press to change display on information panel (MAIN → SUB → Clock Time)

[2-ZONE] button

- Press and hold this button for 1 second or longer to turn on 2-ZONE function; press again to turn 2-ZONE off.

● Radio/TV/SIRIUS mode

* Not supported

● DVD player mode

* Can be operated the same as when 2-ZONE function is OFF.

However, [P.TIME] button / [SET UP] button are disabled, and [MENU] button is disabled when liquid crystal panel is open.

● CD changer mode

* This button is disabled when MAIN zone is set to CD changer mode.

● DVD changer mode

* This button is disabled when MAIN zone is set to DVD changer mode.

8. DCP

The control panel can be detached to prevent theft. When detaching the control panel, store it in the DCP (DETACHABLE CONTROL PANEL) case to prevent scratches.

We recommend taking the DCP with you when leaving the car.

Removing the DCP

1. Press the [SOURCE] button for 1 second or longer to turn off the power.

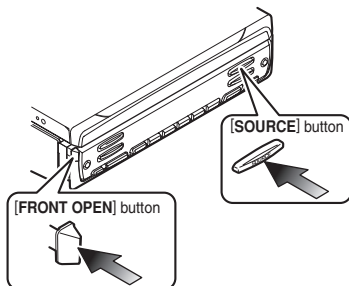

2. Deeply push in [FRONT OPEN] button to unlock the front panel.

* If the front panel does not open fully, gently open it with your hand.

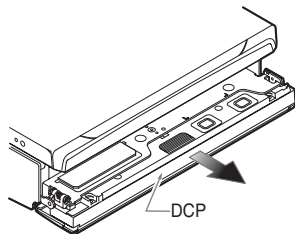

3. Pull the DCP toward you and remove it.
4. Close the HOLD FLAP.

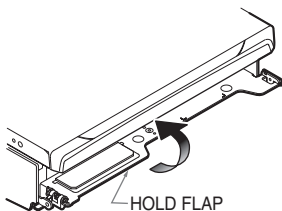

CAUTION

Be sure to close the HOLD FLAP for safety when removing the DCP.

Attaching the DCP

1. Insert the right side of the DCP into the main unit.
2. Insert the left side of the DCP into the main unit.

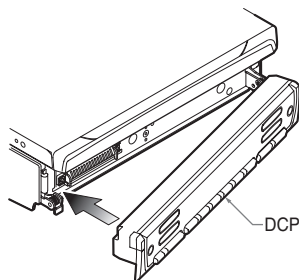

CAUTION

- The DCP can easily be damaged by shocks. After removing it, be careful not to drop it or subject it to strong shocks.
- If the front panel is kept open, the DCP may drop due to vibration of the car. This results in damage to the DCP. So close the front panel or remove the DCP to store into the case.
- The connector connecting the source unit and the DCP is an extremely important part. Be careful not to damage it by pressing on it with fingernails, screwdrivers, etc.
- Remote control unit cannot be used when front panel is open.

Note:

- If the DCP is dirty, wipe off the dirt with a soft dry cloth only.

9. CAUTIONS ON HANDLING

Liquid crystal panel/Generalities

For a longer service life, be sure to read the following cautions.

- Be sure to store the liquid crystal panel inside the main unit when parking the car outdoors for long period of time. The liquid crystal panel will operate properly in a temperature range of 0 to 60°C.
- Don't allow any liquids on the set from drinks, umbrellas etc. Doing so may damage the internal circuitry.
- Do not disassemble or modify the set in any way. Doing so may result in damage.
- Do not draw the liquid crystal panel out and use it as a tray. Also, subjecting the liquid crystal panel to shocks may result in breakage, deformation or other damage.
- Do not let cigarettes burn the display. Doing so may damage or deform the cabinet.
- If a problem should occur, have the set inspected at your store of purchase.
- Do not insert objects or poke in the space between the liquid crystal panel and the main unit when the panel is tilted.
- Do not place anything on the display when the panel is tilted.
- The remote controller may not work if the remote control sensor is exposed to direct sunlight.
- In extremely cold weather, the display movement may slow down and the display may darken, but this is not a malfunction. The display will work normally when the temperature increases.
- Small black and shiny spots inside the liquid crystal panel are normal for LCD products.
- The liquid crystal panel may stop temporarily when it opens or closes, when the engine stops or when it is cold.
- The touchkeys on the display operate when slightly touched. Do not press the touchkey screen with much force.
- Do not push the case surrounding the touchkey panel with much force. This may cause malfunctioning of the touchkeys.

Cleaning

• **Cleaning the cabinet**

Use a soft, dry cloth and gently wipe off the dirt. For tough dirt, apply some neutral detergent diluted in water to a soft cloth, wipe off the dirt gently, then wipe again with a dry cloth.

Do not use benzene, thinner, car cleaner, etc., as these substances may damage the cabinet or cause the paint to peel. Also, leaving rubber or plastic products in contact with the cabinet for long periods of time may cause stains.

• **Cleaning the liquid crystal panel**

The liquid crystal panel tends to collect dust, so wipe it off occasionally with a soft cloth. The surface is easily scratched, so do not rub it with hard objects.

10. DVD VIDEO SYSTEM

DVD video is a high-quality digital video source that provides crisp and clear images. One 12 cm disc contains either one film or four hours of music.

DVD Video Features

This unit provides the following functions in addition to the high image quality and sound quality of DVD video.

Notes:

- The functions described in the section, "**Features**", for example, the recorded language, subtitles, angles, etc. differ with the DVD video disc. Refer to the instructions provided with the DVD video.
- Some disc functions may operate differently than described in this manual.

Multi-sound function

DVD video can store up to 8 languages for one film; select the language of your preference.

- The languages stored on the disc are indicated by the icon shown below.



Multi-angle function

A DVD video that is filmed from multiple angles allows you to select the angle of choice.

- The number of recorded angles are indicated by the icon shown below.

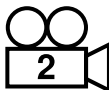

Subpicture (subtitles) function

A DVD video can record subtitles for up to 32 languages and you can select the language of the subtitles you wish to see.

- The number of recorded subtitle languages are indicated by the icon shown below.



Multi-story function

When a DVD video contains more than one story for a film, you can select the story you wish to enjoy. The operation procedures vary with the disc; observe the instructions for selecting a story provided during playback.

Dolby digital

Dolby digital enables up to 5.1 independent multi-channel audio reproduction, the same type of surround system that is also used in movie theaters.

DTS

DTS (Digital Theater System) is a digital sound compression technique developed by Digital Theater Systems, Inc.

This low sound compression format delivers a large amount of data and makes it possible to reproduce a high quality sound.

Menu screens

Menus can be called up during DVD video playback to perform menu setting.

- Example showing menu display

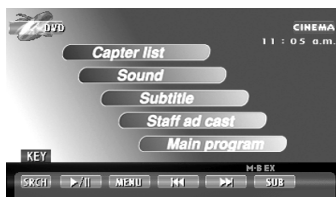

Discs

Playable discs

This DVD video player can play the following discs.

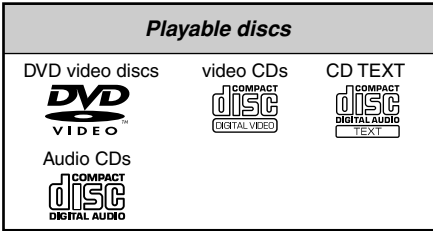

About CD Extra discs

A CD Extra disc is a disc in which a total of two sessions have been recorded. The first session is Audio session and the second session Data session.

Your personally-created CDs with more than 2 data sessions recorded cannot be played on this DVD video player.

Discs that cannot be played back

This DVD video player cannot play back DVD-R, DVD-RAM, DVD-ROM, CD-ROM, Photo CDs.

- Some CDs recorded in CD-R/CD-RW mode may not be usable. (Cause: disc characteristics, cracks, dust/dirt, dust/dirt on player's lens, etc.)

Note on region numbers

The DVD video system assigns a region number to DVD video players and DVD discs by sales area. DVD video players sold in the United States can play back DVD discs with the region number "ALL", "1" or any combination of numbers that also incorporate a "1".

The DVD video region number is marked on the disc jacket as shown below.



TV color system

This DVD player plays NTSC discs only and cannot be used for playback of SECAM discs and PAL discs.

About MP3 playback

This unit can play back CD-R/CD-RW discs on which MP3 music data have been recorded.

For a detailed information, see the page entitled "Listening to an MP3".

About the registered marks etc.

- This product incorporates copyright protection technology that is protected by method claims of certain U.S. patents and other intellectual property rights owned by Macrovision Corporation and other rights owners. Use of this copyright protection technology must be authorized by Macrovision Corporation, and is intended for home and other limited viewing uses only unless otherwise authorized by Macrovision Corporation. Reverse engineering or disassembly is prohibited.
- Manufactured under license from Dolby Laboratories.
"Dolby", "Pro Logic", and the double-D symbol are trademarks of Dolby Laboratories.
- "DTS" and "DTS Digital Out" are trademarks of Digital Theater Systems, Inc.
- "iPod" is for legal or rightholder-authorized copying only. Don't steal music.
"iPod" is a trademark of Apple Computer, Inc., registered in the U.S. and other countries.

11. OPERATIONS

Basic Operations

Note: Be sure to read this chapter referring to the front diagrams of chapter "3. CONTROLS" on page 5 (unfold).

⚠ CAUTION

When the unit is turned on, starting and stopping the engine with its volume raised to the maximum level may harm your hearings. Be careful about adjusting the volume.

Note:

- Use this unit after starting the engine.



Engine ON position

Turning on and off the power

Note:

- Be careful about using this unit for a long time without running the engine. If you drain the car's battery too far, you may not be able to start the engine and this can reduce the service life of the battery.

1. Press the [SOURCE] button.
2. The illumination and display on the unit light up. The unit automatically remembers its last operation mode and will automatically switch to display that mode.
3. Press and hold the [SOURCE] button for 1 second or longer to turn off the power for the unit.

Note:

- About the "SYSTEM CHECK"

The confirmation of connected equipment must be performed for this unit only when the wiring connection is complete and power is turned on to the unit first. When the power is supplied, "PUSH PWR" appear in the display. Press the [SOURCE] button, the system check starts inside the unit. When "COMPLETE" and "PUSH PWR" appear alternately, press once again the [SOURCE] button.

Selecting a mode

1. Press the [SOURCE] button to change the mode of operation.
2. Each time you press the [SOURCE] button, the mode of operation changes in the following order:

Radio mode → (SIRIUS mode) → DVD mode → (CD changer mode) → (DVD changer mode) → (TV mode) → VISUAL mode → (iPod mode) → Radio mode...

- * External equipment not connected with CeNET is not selected.
- * When 2-ZONE function is ON, the main unit's [SOURCE] button operates for the MAIN zone only; use the accessory remote control unit to switch to a SUB zone source.

Adjusting the volume

1. Operate the [VOL] button in the direction of the + (up) or – (down) to adjust the volume;
 - + : Increases the volume.
 - : Decreases the volume.
- * The volume level indicated in the display is in a range from 0 (minimum) to 33 (maximum).

⚠ CAUTION

While driving, keep the volume at a level at which external sounds can be heard.

Switching the display

When the panel is closed:

1. Press the [DISP] button to select the desired display.

Each time you press the [DISP] button, the display switches in the following order:

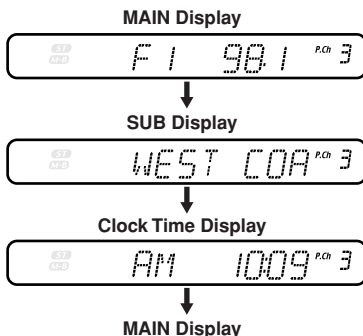

Notes:

- Once selected, the preferred display becomes the default display. When a function adjustment such as volume is made, the display momentarily switches to that function's display, then returns back to the preferred display several seconds after the adjustment.
- If a title has been input, it is shown in the SUB display. If no title has been input, "NO TITLE" appears in the display. To input a title, refer to the subsection "Entering titles" in "Other Functions" section.
- For CD and TV, some special characters of the title will not be displayed on the Information Panel of the DCP. In this case, those characters will only be left blank.
- SUB displays do not appear when panel is open.
- SUB displays do not appear when 2-ZONE function is ON.

Basic Operations

Opening and turning the liquid crystal panel

⚠ WARNING

- To prevent the battery from going dead, operate this unit with the engine running, if possible.
- When the liquid crystal panel is operating, be careful not to get your hand or finger caught between the panel and main unit or the instrument panel of the car.
- Do not move the liquid crystal panel by hand.

Standing up the liquid crystal panel

1. Press the [OPEN] button and the liquid crystal panel comes out and stand up automatically.

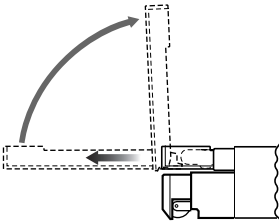

- * While the liquid crystal panel is opening or closing, the blue-lighted [SOURCE] button (and other buttons) will flash.

Notes:

- If the liquid crystal panel stops in the middle of its operation, press the [OPEN] button to house the panel and press the button again to stand it up. The unit enters the same display mode as the display was turned off the last time.
- If the liquid crystal panel stops at any point less than 70°, the electronic beep will sound.

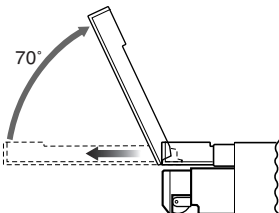

Panel calibration function

The liquid crystal panel's maximum angle of inclination can be adjusted to match the installation configuration within the automobile.

- Perform this with the panel in its closed position.
1. Deeply push in [FRONT OPEN] button to unlock the front panel.
 2. Press and hold the [TILT] button for 2 seconds or longer, until the electronic beep is heard.
 3. The beep will sound twice, and the panel will rise and the calibration function will begin.
 4. After completion of the calibration, the panel will close automatically.
 - * If the panel does not strike the instrument panel or other parts of the car during calibration, the maximum inclination will be 110°.
 - * If the panel strikes a car part during calibration within a range of 70° inclination, the maximum downward inclination will be 70°.

Adjusting the angle of the liquid crystal panel

The angle of the liquid crystal panel can be adjusted depending on the mounting angle of the unit or light coming into the car.

● To adjust the angle

1. Every time the [TILT] button is pressed, the liquid crystal panel tilts forward or backward. The adjusted angle is stored in memory.
 - * Adjustment is possible within the range 70° to 110°, or within the range set by panel calibration.
 - * There are 5 adjustable angle available.

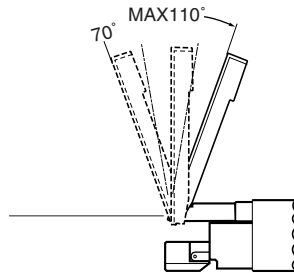

Basic Operations

Housing the liquid crystal panel

1. Press the [OPEN] button and the liquid crystal panel is housed automatically.

Note:

- When leaving this unit unused for a long period of time or leaving your car, be sure to house the liquid crystal panel into the main unit.

Turning the liquid crystal panel horizontal (Air conditioner operation mode)

When the way the liquid crystal panel is mounted hinders the operation of the air conditioner, the position of the panel can be turned horizontal temporarily.

1. Press and hold the [OPEN] button when the liquid crystal panel is upright, and release the button when a beep is heard.
2. The liquid crystal panel turns horizontal.
 - * Press the [OPEN] button again when the liquid crystal panel is in the horizontal position, and the panel returns to the original position.
 - * The unit can also be set so that the panel returns to its original angle after a set time in the horizontal position (See P. 28).

Mute

1. When in the radio, SIRIUS, VISUAL or TV mode, each time you press the [MUTE] button, mute is turned on and off. "MUTE" appears when mute is turned on.
2. In modes other than radio, SIRIUS, VISUAL, or TV, enable the MUTE function by holding the [MUTE] button depressed for 1 second or longer.

Regarding the menu screen's [RTN] and [ESC] keys

- [RTN]: Touch the [RTN] key to return to the previous screen.
- [ESC]: Touch the [ESC] key to return to the main screen.

In the ADJUST mode, pressing the [ADJ] button will also cause a return to the main screen.

In cases where this kind of multiple key response is supported, the following kind of notation will be used:

Touch the [RTN] key, [ESC] key, or press the [ADJ] button.

Adjusting the AUDIO

Note:

- When the separately-sold 5.1 ch Surround Decoder (DVH940) is used, the bass and treble tone adjustments cannot be made. To adjust the tone, refer to the section "5.1 ch Surround Decoder Operations".

Adjusting the balance/fader

1. Press the [ADJ] button, then touch the [AUDIO] key.
2. Touch the [BAL/FAD] key.
3. Touch the [▲] or [▼] key to adjust to the fader level.
 - * The factory default setting is "0". (Adjustment range: front 13 to rear 13)
 - [▲] key: Emphasized the sound from the front speakers.
 - [▼] key: Emphasized the sound from the rear speakers.
4. Touch the [◀] or [▶] key to adjust to the balance level.
 - * The factory default setting is "0". (Adjustment range: left 12 to right 12)
 - [◀] key: Emphasized the sound from the left speakers.
 - [▶] key: Emphasized the sound from the right speakers.
5. Touch the [RTN] key, [ESC] key, or press the [ADJ] button.

Adjusting the BASS

The bass gain, bass frequency (center frequency) and bass Q can be adjusted as follows.

1. Press the [ADJ] button, then touch the [AUDIO] key.
2. Touch the [BASS] key.
3. When the bass type selection screen is displayed, touch the key for the desirable type to select it.
4. Touch the [▲] or [▼] key to adjust to desirable level.
 - GAIN : -6 to 8 (The factory default setting is "0")
 - FREQ. : 50Hz/80Hz/120Hz (The factory default setting is "50")
 - Q : 1/1.25/1.5/2 (The factory default setting is "1")
5. Touch the [RTN] key, [ESC] key, or press the [ADJ] button.

Basic Operations

Adjusting the MID

The MID gain, MID frequency (center frequency) and MID Q can be adjusted as follows.

1. Press the **[ADJ]** button, then touch the **[AUDIO]** key.
2. Touch the **[MID]** key.
3. When the bass type selection screen is displayed, touch the key for the desirable type to select it.
4. Touch the **[▲]** or **[▼]** key to adjust to desirable level.

GAIN : -6 to 6 (The factory default setting is "0")

FREQ. : 700Hz/1kHz/2kHz (The factory default setting is "1k")

Q : 1.5/2 (The factory default setting is "2")
5. Touch the **[RTN]** key, **[ESC]** key, or press the **[ADJ]** button.

Adjusting the TREBLE

The treble gain and treble frequency (center frequency) can be adjusted as follows.

1. Press the **[ADJ]** button, then touch the **[AUDIO]** key.
2. Touch the **[TREBLE]** key.
3. When the bass type selection screen is displayed, touch the key for the desirable type to select it.
4. Touch the **[▲]** or **[▼]** key to adjust to desirable level.

GAIN : -6 to 6 (The factory default setting is "0")

FREQ. : 8kHz/12kHz (The Factory default setting is "12K")
5. Touch the **[RTN]** key, **[ESC]** key, or press the **[ADJ]** button.

Adjusting the non fader output volume

You can adjust the volume output from the unit's non fader output terminal.

1. Press the **[ADJ]** button, then touch the **[AUDIO]** key.
2. Touch the **[NON FADER VOL]** key.

3. Touch the **[▲]** or **[▼]** key to adjust to desirable level.
 - * The factory default setting is "0". (Setting range: -6 to 6)
4. Touch the **[RTN]** key, **[ESC]** key, or press the **[ADJ]** button.

Turning on/off the MAGNA BASS EXTEND

The MAGNA BASS EXTEND does not adjust the low sound area like the normal sound adjustment function, but emphasizes the deep bass sound area to provide you with a dynamic sound.

1. Press the **[ADJ]** button, then touch the **[AUDIO]** key.
2. Touch the **[M•B EX]** key.

Each time you touch the **[M•B EX]** key, you can switch between "ON" and "OFF". When the MAGNA BASS EX effect is turned on, "M•B EX" lights in the display.
3. Touch the **[RTN]** key, **[ESC]** key, or press the **[ADJ]** button.

Adjusting the MONITOR

Adjusting the brightness and tone of color

Notes:

- This function is not available when the display is stored.
- The HUE setting can be adjusted only when the NTSC mode is selected.
- Switch to the VISUAL/DVD player(DVD video or video CD)/DVD changer/TV mode you see.

1. Press the [ADJ] button to switch to the ADJUST mode menu.
2. Touch the [MONITOR] key.
3. Touch the [MONI ADJ] key to display [BRIGHT], [HUE] and [COLOR] key. Touch the [BRIGHT], [HUE] and [COLOR] key to adjust BRIGHT, HUE and COLOR.
 - “BRIGHT”:
Adjust the brightness of the display.
 - “HUE”:
Adjust the tone of color (red is emphasized or green is emphasized)
 - This operation is available only when the car is stopped and the parking brake is applied.
 - “COLOR”:
Adjust the color saturation.
 - This operation is available only when the car is stopped and the parking brake is applied.
4. Operate the touch key to adjust a level.
 - “BRIGHT”:
[▶] Press to make image brighter
[◀] Press to make image dimmer
 - “HUE”:
[▶] Press to increase green
[◀] Press to increase red
 - “COLOR”:
[▶] Press to increase color depth
[◀] Press to decrease color depth
5. Touch the [RTN] key, [ESC] key, or press the [ADJ] button.

Adjusting the dimmer level

Use to adjust panel brightness when car lights are ON/OFF.

● The factory default:

When the car light is off: Brightest setting (58 steps)

When the car light is on: Medium brightness (29 steps)

1. When the panel is open, press the [ADJ] button to display the ADJUST mode menu.
2. Touch the [MONITOR] key, and touch the [DIMMER LEVEL] key to adjust the dimmer level.
3. Touch the [▶] or [◀] key to adjust.
4. Touch the [RTN] key, [ESC] key, or press the [ADJ] button.

Warning display when CCD camera is installed

When a TV tuner (sold separately) is installed together with optional CCD camera, the following warning message is displayed during use of the CCD camera: “**Make sure of safety around your vehicle**”

* The factory default setting is “ON”

1. Press the [ADJ] button.
2. Touch the [MONITOR] key, and touch the [CCD WARNING] key to switch between “ON” and “OFF”.
3. Touch the [RTN] key, [ESC] key, or press the [ADJ] button.

Switching the VTR system between NTSC and PAL

* This function is enabled only when the panel is open.

* The factory default setting is “NTSC”.

Switch to the VISUAL/VTR in TV mode you use.

1. Press the [ADJ] button to switch to the ADJUST mode menu.
2. Touch the [MONITOR] key.
3. Touch the [NTSC/PAL] key to select “NTSC” or “PAL”.
4. Touch the [RTN] key, [ESC] key, or press the [ADJ] button.

Front monitor lock

1. Press and hold the [ADJ] button for 1 second or longer.
2. Press the [SOURCE] button to select the desired mode.
3. To cancel the monitor lock, press the [ADJ] button.

The screen shows the image of the selected mode.

Basic Operations

Adjusting the GENERAL

Setting the BEEP

- * The sound heard when you make operations is called “beep”. The unit can be set up so that it does not produce this beep sound.
 - * The factory default setting is “**BEEP ON**”.
1. When the panel is open, press the **[ADJ]** button to select the ADJUST mode menu.
 2. Touch the **[GENERAL]** key.
Touch the **[BEEP]** key to select “**ON**” and “**OFF**”.
 3. Touch the **[RTN]** key, **[ESC]** key, or press the **[ADJ]** button.

Setting the button illumination

- * The factory default setting is “**GREEN**” (green).
1. When the panel is open, press the **[ADJ]** button to select the ADJUST mode menu.
 2. Touch the **[GENERAL]** key.
 3. Touch the **[KEY ILLUMI]** key to select “**RED**” (red) or “**GREEN**” (green).
 4. Touch the **[RTN]** key, **[ESC]** key, or press the **[ADJ]** button.

Clock Adjustment

1. When the panel is open, press the **[ADJ]** button to select the ADJUST mode menu.
2. Touch the **[GENERAL]** key.
Touch the **[CLOCK]** key to adjust the time.
3. Touch the **[▲]**, **[▼]**, **[a.m]** or **[p.m]** key to adjust the time, then touch the **[SET]** key.
* The time is displayed in 12-hour format.
4. Touch the **[RTN]** key, **[ESC]** key, or press the **[ADJ]** button.

Setting the Auto Panel

When you remove or attach the DCP, you can set the liquid crystal panel automatically housing or opening.

- * The factory default setting is “**ON**”.
1. Press the **[ADJ]** button to select the ADJUST mode menu.
 2. Touch the **[GENERAL]** key.
Touch the **[AUTO PANEL]** key to set “**ON**”, “**OFF**” or “**CLOSE**”.

ON: The liquid crystal panel houses automatically after removing the DCP.

And the liquid crystal panel open automatically after attaching the DCP.

OFF: Normal operation.

CLOSE: The liquid crystal panel houses automatically after removing the DCP.

3. Touch the **[RTN]** key, **[ESC]** key, or press the **[ADJ]** button.

Switching CONNECT(connect)

Make the following settings when an external device is connected to the Visual terminal.

NAVI: when a navigation system is connected

- * When a navigation system is connected, use the monitor lock function. Locking the monitor locks the screen size in F.WIDE mode (full wide) and the VTR system to NTSC.

OTHERS: for external devices other than a navigation system

NONE: when no external devices are connected

- * The factory default setting is “**NONE**”.

1. When the panel is open, press the **[ADJ]** button to display the ADJUST mode menu.
2. Touch the **[GENERAL]** key.
Touch the **[CONNECT]** key to select “**NAVI**” or “**OTHERS**” or “**NONE**”.
3. Touch the **[RTN]** key, **[ESC]** key, or press the **[ADJ]** button.

Time setting in air conditioner operation mode

This setting can be used to adjust the time the panel stays in the horizontal position when in the air conditioner operation mode.

- * The factory default setting is “**10s**”.

1. Press the **[ADJ]** button.
2. Touch the **[GENERAL]** key.
3. Touch the **[HVAC MODE]** key to set to “**5s**”, “**10s**”, or “**30s**”.
4. Touch the **[RTN]** key, **[ESC]** key, or press the **[ADJ]** button.

2-ZONE Function

About the 2-ZONE function

The 2-ZONE function is a function that outputs separate sounds from the MAIN zone and SUB zone by simultaneously operating two sources in the one center unit, thereby allowing plural listeners to enjoy separate music sources.

The 2-ZONE function allows internal sources (radio, DVD, VISUAL) and external sources via CeNET connection (for example, CD changers) to be played respectively on MAIN zone and SUB zone. For examples of playback possibilities, see the section "Setting the 2-ZONE function".

The sources of the MAIN zone are played back from the speakers of the vehicle side, and those of the SUB zone are from the headphone systems (WH100).

Sound volume control on the SUB zone is performed by the headphone system (WH-100).

Notes:

- Except DVD/VISUAL, the MAIN and SUB zones cannot simultaneously use sources inside this unit. Also, external equipment connected via CeNET cannot simultaneously be used.
- The ISR function cannot be operated when the 2-ZONE function is turned on.
- The Audio mode function cannot be set for the sources of the SUB zone.
- If any of following external equipment is connected, this function is disenabled.
- 5.1 channel surround decoder (DVC940)
- When an iPod is connected, the SUB zone switches to DVD mode.
- If SUB zone is set to VISUAL when 2-ZONE is ON, connecting an iPod will cause the 2-ZONE function to turn OFF.

Setting the 2-ZONE function

* The factory default setting is "OFF".

1. Hold the remote control unit's [2-ZONE] button depressed (about 1 second) to turn the 2-ZONE function ON.
 - The function can also be switched by touching and holding the main menu's [2ZONE] key (about 1 second).



2-ZONE indication

Icon color indicates ON/OFF

- OFF : blue
- ON : green

- When 2-ZONE function is turned ON, the main unit's buttons operate to control the MAIN zone source, while the remote control unit's buttons operate to control the SUB zone source.

2. To turn the 2-ZONE function OFF, either press the remote control unit's [2-ZONE] button, or touch the [2ZONE] key on the main menu.

● Source switching when 2-ZONE function is OFF

Radio → (SIRIUS) → DVD → (CD changer) → (DVD changer) → (TV) → VISUAL → (iPod) → Radio ...

● MAIN zone source switching when 2-ZONE function is ON:

Press the main unit's [SOURCE] button to switch sources. The order of switching is Radio → (SIRIUS) → DVD → (CD changer) → (DVD changer) → (TV) → VISUAL → (iPod) → Radio ...

● SUB zone source switching when 2-ZONE function is ON:

Press the remote control unit's [SOURCE] button to switch sources.

- When no iPod is connected, switching is DVD mode → VISUAL mode
- When an iPod is connected, only the internal DVD can be played.

Basic Operations

Monitor image and sound with 2-ZONE ON/OFF

● With 2-ZONE function OFF

(*1)	Front monitor lock ON		Front monitor lock OFF	
	Visual connection [OTHERS]	Visual connection [NAVI]	Visual connection [OTHERS]	Visual connection [NAVI]
Front image (receiver screen)	Image of device connected to the Visual terminal (*3)	Image of device connected to the Visual terminal	Displays image of mode selected using the [SOURCE] button.	
Rear monitor image (separately sold)	Displays image of mode selected using the [SOURCE] button. (*2)			
Audio output	Sound from mode selected with [SOURCE] button is output from 4ch speaker, NON-FADER, and AUDIO-OUT.			

● When 2-ZONE function is ON

(*1)	Front monitor lock ON		Front monitor lock OFF	
	Visual connection [OTHERS]	Visual connection [NAVI]	Visual connection [OTHERS]	Visual connection [NAVI]
Front image (receiver screen)	Image of device connected to the Visual terminal (*3)	Image of device connected to the Visual terminal	Displays image of mode selected using the main unit's [SOURCE] button	
Rear monitor image (separately sold)	Displays image from mode (DVD or VISUAL) selected with remote control unit's [SOURCE] button.			
Audio output	<ul style="list-style-type: none"> • Sound from mode selected with main unit's [SOURCE] button is output from 4ch speaker, and AUDIO OUT. • Sound from mode selected with remote control unit's [SOURCE] button is output from NON-FADER. 			

*1 A device connected to the Visual terminal should be set up as described in the section "Switching CONNECT".

*2 No image is displayed on the rear monitor when a non-image mode such as radio, SIRIUS, CD, etc. is engaged.

*3 For safety reasons, this image is not displayed when the vehicle is moving. The picture can be watched only when the vehicle is standing still and the parking brake is engaged.

⚠ CAUTION

When 2-ZONE is ON, the NON-FADER OUTPUT level is fixed at equivalent to VOL27 (high volume).

When an external amplifier or speakers are attached to the NON-FADER OUTPUT connectors, do not set the unit to the 2-ZONE mode, since a high volume of sound will be suddenly output from the speakers connected to the NON-FADER OUTPUT, potentially causing damage to the connected amplifier or speakers.

FM reception

For enhanced FM performance the **MIGHTUNE**[®] tuner includes signal actuated stereo control, Enhanced Multi AGC, Impulse noise reduction circuits and Multipath noise reduction circuits.

Listening to the radio

1. Press the **[SOURCE]** button and select the Radio mode. The frequency is displayed.
2. Press the **[BAND]** button and select the radio band. Each time the button is pressed, the radio reception band changes in the following order:
FM1 → FM2 → FM3 → AM → FM1...
FM1 → FM2 → FM3 → AM → FM1...
3. Press the **[◀▶]** or **[▶▶]** button to tune in the desired station.

Seek tuning

1. Press the **[BAND]** button and select the desired band. (FM or AM)
2. Tune in to a station.
 - * If **"MANU"** is lit in the display, press and hold the **[BAND]** button for 1 second or longer. **"MANU"** in the display goes off and seek tuning is now available.
 - * The same operation is also available by using the **[BAND]** key.
3. Press the **[◀▶]** or **[▶▶]** button to automatically seek a station.

When the **[▶▶]** button is pressed, the station is sought in the direction of higher frequencies; when the **[◀▶]** button is pressed, the station is sought in the direction of lower frequencies.

* The same operation is also available by using the **[◀◀]** or **[▶▶]** key.

Selecting stations with the KEY PAD

* This function displays the KEY PAD on the screen enabling you to tune by entering a frequency.



1. Touch the **[SRCH]** key to switch the KEY PAD.
2. Touch the **[0]~[9]** key corresponding with the frequency you desired. When you touch the wrong number (**[0]~[9]** key), you can cancel that to touch the **[CLR]** key.
3. Touch the **[ENT]** key. The radio station you required would be tuned.
4. Touch the **[ESC]** key.

Manual tuning

There are 2 ways available: Quick tuning and step tuning.

When you are in the step tuning mode, the frequency changes one step at a time. In quick tuning mode, you can quickly tune the desired frequency.

1. Press the **[BAND]** button and select the desired band. (FM or AM)
 - * If **"MANU"** is not lit in the display, press and hold the **[BAND]** button for 1 second or longer. **"MANU"** appears in the display and manual tuning is now available.
 - * The same operation is also available by using the **[BAND]** key.
2. Tune into a station.
 - **Quick tuning:**
Press and hold the **[◀▶]** or **[▶▶]** button for 1 second or longer to tune in a station.
 - **Step tuning:**
Press the **[◀▶]** or **[▶▶]** button to manually tune in a station.

Recalling a preset station

A total of 24 preset positions (6-FM1, 6-FM2, 6-FM3, 6-AM) exists to store individual radio stations in memory. Pressing the corresponding **[DIRECT]** button recalls the stored radio frequency automatically.

There are 2 ways available to recall the preset station.

- **Using the [DIRECT] button**
1. Press the **[BAND]** button and select the desired band. (FM or AM)
 2. Press the corresponding **[DIRECT]** button to recall the stored station.
 - * Press and hold one of the **[DIRECT]** buttons for 2 seconds or longer to store that station into preset memory.

Radio Operations

● Using the LIST screen

1. Touch the [LIST] key.

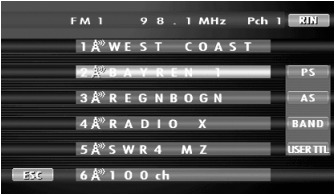

2. Touch the corresponding [DIRECT] key to recall the stored station.
 - * You can select the desired band to touch the [BAND] key.
 - * Touch and hold the [DIRECT] key for 2 seconds or longer to store the current station into preset memory.
3. Touch the [RTN] key or the [ESC] key to return to the previous mode.

Manual memory

● Using the [DIRECT] button

1. Press the [BAND] button and select the desired band. (FM or AM)
2. Select the desired station with seek tuning, manual tuning, or preset tuning.
3. Press and hold one of the [DIRECT] buttons for 2 seconds or longer to store the current station into preset memory.

● Using the LIST screen

1. Press the [BAND] button and select the desired band. (FM or AM)
2. Select the desired station with seek tuning, manual tuning, or preset tuning.
3. Touch the screen to display the menu, then touch the [LIST] key.
4. Touch and hold one of the [DIRECT] key for 2 seconds or longer to store the current station into the preset memory.

Auto store

Auto store is a function for storing up to 6 stations that are automatically tuned in sequentially. If 6 receivable stations cannot be received, a previously stored station remains unoverwritten at the memory position.

1. Press the [BAND] button and select the desired band. (FM or AM)
2. Touch the [LIST] key.
3. Touch and hold the [AS] key for 2 seconds or longer.

The stations with good reception are stored automatically to the preset channels.

Preset scan

Preset scan receives the stations stored in preset memory in order. This function is useful when searching for desired station in memory.

1. Touch the [LIST] key.
2. Touch the [PS] key to start preset scan. The unit starts scanning each station for 7 seconds sequentially.
3. When the desired station is turned in, touch the [PS] key again to continue receiving that station.

Instant station recall (ISR)

Instant station recall is a special radio preset that instantly accesses a favorite radio station at a touch of a button. The ISR function even operates with the unit in other modes.

● ISR memory

1. Select the station that you wish to store in ISR memory.
2. Press and hold [ISR] button for 2 seconds or longer.

● Recalling a station with ISR

1. In any mode, press [ISR] button to turn on the radio function and tune the selected radio station. "ISR" appears in the display. Press [ISR] button again to return to the previous mode.
 - * ISR is disabled when 2-ZONE is ON.

Changing DVD System Settings

Notes:

- If the *SETUP* operation is performed in the middle of DVD video play, the disc plays from the beginning.
- Various settings of the *SETUP* menu cannot be made with the remote control unit.

Selecting the DVD SETUP menu

1. Touch the screen to show the menu screen.
2. Touch the **[SUB]** key to display the sub menu.
3. Touch the **[SETUP]** key to display the DVD SETUP menu.

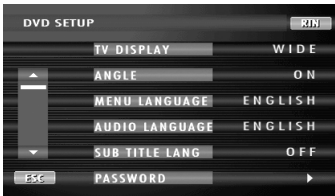

4. Touch the **[▼]** key. Touch the **[▲]** key to return to the previous menu.

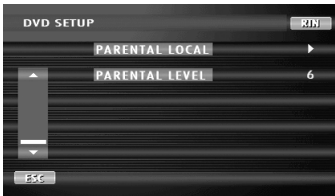

5. Touch the **[RTN]** key (**[ESC]** key).

Setting up the screen size

Set up the screen size according to the rear view monitor which is connected to this unit.

1. Follow the steps 1 to 3 in “**Selecting the DVD SETUP menu**”.
2. Each time you touch the **[TV DISPLAY]** key, you can change among the screen size in the following order.

“**WIDE**” → “**N PS**” → “**N LB**” → “**WIDE**”

* The factory default setting is “**WIDE**”.

● When watching through a conventional type of the rear view monitor (4:3)

- **N PS** : The leftmost and rightmost areas of the screen are cut off.

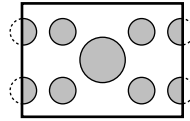

This function allows displaying the important part of image fully on the screen. In some cases, image is displayed while being panned (scrolled).

- **N LB** : A black zone is created in the top and bottom areas of the screen.

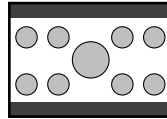

This method displays Cinema Scope and Vista Vision images without cutting them off by creating a black zone on the top and bottom gaps.

● When watching through a wide type of the rear view monitor (16:9)

- **WIDE**:

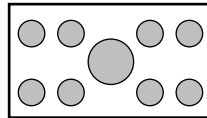

3. Touch the **[RTN]** key (**[ESC]** key).

Setting up the angle mark display

You can set up so that the angle mark appears on scenes where the angles can be switched.

1. Follow the steps 1 to 3 in “**Selecting the DVD SETUP menu**”.
2. Touch the **[ANGLE]** key to select “**ON**” or “**OFF**”.
 - * The factory default setting is “**OFF**”.
3. Touch the **[RTN]** key (**[ESC]** key).

Setting up the disc menu language.

1. Following the steps 1 to 3 in “**Selecting the DVD SETUP menu**”, touch the **[MENU LANGUAGE]** key.

DVD Video Player Operations

- Touch the key to select a desired language to set it.
 - * The factory default setting is "ENGLISH".
- Touch the [RTN] key ([ESC] key).

Setting up the audio language

- Following the steps 1 to 3 in "Selecting the DVD SETUP menu", touch the [AUDIO LANGUAGE] key.
- Touch the key to select a desired language to set it.
 - * The factory default setting is "ENGLISH".
- Touch the [RTN] key ([ESC] key).

Setting up the subtitle language

- Following the steps 1 to 3 in "Selecting the DVD SETUP menu", touch the [SUB TITLE LANG.] key.
- Touch the key to select a desired language to set it.
 - * The factory default setting is "ENGLISH".
- Touch the [RTN] key ([ESC] key).

Setting up the password for setting up of the parental level

- Following the steps 1 to 3 in "Selecting the DVD SETUP menu", touch the [PASSWORD] (password) key.
- Touch the ten-key(0 to 9) to input a 4-digit password.
 - * The factory default setting is "0000".
 - * Input "4356" to return password to "0000".
 - Input an old password, and touch the [ENT] key.
 - Input a new password, and touch the [ENT] key.
- Touch the [RTN] key ([ESC] key).

Note:

When a disc with view limited is played
When a disc with view limited is played, the input screen requiring you to input the password may appear. When this happens, enter the correct password, otherwise play does not start.

Setting up the country code

Set up the country number for setting up of the parental level.

- Following the steps 1 to 4 in "Selecting the DVD SETUP menu", touch the [PARENTAL LOCALE] key.
- Touch the ten-key(0 to 9) to input a 4-digit country code.
 - * The factory default setting is "8583"(U.S.A).

Country	Input code
CANADA	6765
UNITED STATES	8583
AMERICAN SAMOA	6583
BERMUDA	6677
PUERTO RICO	8082
ST. PIERRE AND MIQUELON	8077
VIRGIN ISLANDS (U.S)	8673

- Touch the [ENT] key.
- Touch the [RTN] key ([ESC] key).

Setting up the parental level

You can change the level of parental lock (audio-visual restriction).

This function allows cutting scenes that are unfavorable for children or replacing them automatically with other scenes prepared in advance. For example, by replacing scenes of radical violence or portrayals of sex with safe scenes, you can make a trouble-free story as if it were so from the beginning.

- Following the steps 1 to 4 in "Selecting the DVD SETUP menu", touch the [PARENTAL LEVEL] key.
- When you touch the [▲] or [▼] key, PASSWORD input screen is displayed.
- Touch the ten-key(0 to 9) to input a 4-digit password, and touch the [ENT] key.
 - * The factory default setting of the password is "0000".
- Touch the [▲] or [▼] key to select level 1 to 8, or 0 (no parental).
 - * The factory default setting is "8".
- Touch the [RTN] key ([ESC] key).

The relationship between DVD video category codes and parental level are shown in the table below. Use this table when setting the parental level.

LEVEL7	NC-17 (NO ONE 17 AND UNDER ADMITTED)
LEVEL6	R (RESTRICTED)
LEVEL4	PG-13 (PARENTS STRONGLY CAUTIONED)
LEVEL3	PG (PARENTAL GUIDANCE SUGGESTED)
LEVEL1	G (GENERAL AUDIENCES)

- The contents that the parental level restricts varies with the country code.

Basic Operations

Loading a disc

Insert a disc into the centre of the insertion slot with the label side facing up. The disc plays automatically after loading.

Notes:

- Never insert foreign objects into the disc insertion slot.
- If the disc is not inserted easily, there may be another disc in the mechanism or the unit may require service.
- 8 cm (single play) discs cannot be used.

CAUTION

With the screen open, a driver may not see the disc insertion slot. For your safety, insert a disc with the screen closed.

Watching/Listening to a disc already inserted

1. Press the [SOURCE] button to select the DVD mode. Play starts automatically. If no disc is loaded in the unit, "NO DISC" appears in the display.

WARNING

- Videos may be played back with particularly loud sound. Increase the volume gradually from the minimum after the video images are displayed.
- For your safety, the driver should not watch the video or operate the controls while driving. Please note that watching and operating the video while driving are prohibited by law in some countries.

Note:

- For your safety, the VRX755VD has a safety function which turns off the picture when the car is moving, so only the audio can be heard. The picture can only be watched when the car is stopped and the parking break is applied.

Pausing play

1. Press the [▶/||] button to pause play. "PAUSE" appears in the display.
2. To resume disc play, press the [▶/||] button again.

DVD Video Player Operations

Ejecting a disc

1. Press the [▲] button a disc ejects. "EJECT" appears in the display. The play mode then switches to Radio.

* If a disc is left in the ejected position for 15 seconds, the disc is automatically reloaded (Auto reload). In this case, however, the play mode will remain set to Radio.

Note:

- If you force a disc into before auto reloading, this can damage the disc.

DVD Video Operations

Watching a DVD-Video

After disc loading, the play mode is automatically engaged.

- Button operation may not be allowed depending on the story of the disc.

● After the menu screen is displayed

For normal DVD-Video discs, the DVD menu screen appears.

After the DVD menu screen is displayed, select an item in the following operations and play it back.

Showing the DVD menu

1. Touch the screen to show the menu screen. Touch the [MENU] key during playback. The DVD menus appears.

The displayed contents may differ, depending on the DVD software.

- Example showing DVD menu display



2. To select the DVD menu contents, touch the [KEY] key. The "Cross KEY PAD" (▲▼◀▶) is displayed.
3. Touch the [NUM] key, the display changes to the "TEN KEY PAD" (0~9).

Touch the [+] key to return to the "Cross KEY PAD".

4. Select the DVD menu contents use either the "Cross KEY PAD" on the "TEN KEY PAD" according to the disc contents menu.
5. Touch the [ENT] key and touch the [ESC] key.

Switching KEY PAD position

When the KEY PAD becomes difficult to view in the menu display, you can move it to the other side of the screen.

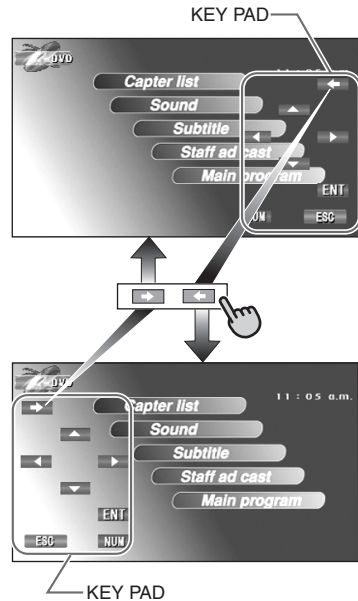

Stopping playback

1. Touch and hold the [▶/||] key for 1 second or longer during playback. Playback stops.
2. To resume playback. Touch the [▶/||] key, and playback resumes from the scene where playback is stopped.

Pausing playback

1. Press the [▶/||] button or touch the [▶/||] key during playback. Playback pauses.
2. To resume playback. Press the [▶/||] button, and playback resumes.

Slow playback

1. Press the [▶/⏪] button or touch the [▶/⏪] key, then press and hold the [▶▶] button or the [▶▶] key. While the button or key is being pressed, slow playback continues at the speed 1/3 times the normal playback.
 - Slow playback cannot be performed in the backward direction. In addition, audio cannot be reproduced during slow playback.

Skipping a chapter (searching)

About chapter

Chapter means a small segment to divide the data area of the disc.

1. Press the [◀◀] / [▶▶] button or touch the [◀◀] / [▶▶] key during playback. Chapters are skipped, as many as the times the button is pressed, and playback starts.

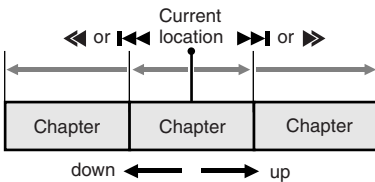

- Press the [▶▶] button, and playback starts from the beginning of the next chapter.
- Press the [◀◀] button, and playback starts from the beginning of the current chapter. When this button is pressed again within about 2 seconds, playback starts from the beginning of the previous chapter.
- The unit may return to the menu screen when the [▶▶] or [◀◀] button is pressed.
- The same operation can be performed by touching the screen to display the menu screen, then touching the [◀◀] or [▶▶] key.

Fast forward and fast backward

1. Press and hold the [◀◀] or [▶▶] button during playback. Press and hold the button, and the playback speed becomes 5-time faster first and then 20-time faster 3 seconds later. Release the button, and the normal speed is restored.
 - No audio is reproduced during fast forward and fast rewind operation.
 - The same operation can be performed by touching the screen to display the menu screen, then touching the [◀◀] or [▶▶] key.
 - The fast forward and fast rewind speed may differ depending on the disc.
 - The menu screen may appear when the button is pressed.

Searching with a chapter/title number

You can locate the beginning of the scene using the chapter numbers or title numbers recorded on the DVD-Video disc.

1. Touch the screen to display the menu screen.
2. Touch the [SRCH] key.

Each time you touch the [SFT] key, you can switch between title number input “[T**]” and chapter number input “[C***]”.

• Title

A large segment to divide the data area of the disc.

• Chapter

A small segment to divide the data area of the disc.

3. Input the number of the title that you want to play back with the [0] to [9] key.
4. Touch the [ENT] key.

Playback starts from the scene of the input title number or chapter number.

- If the input title number does not exist or searching with a title number is not allowed, the screen image will not change.
5. Touch the [ESC] key.

DVD Video Player Operations

Scan playback

Scans and plays back all chapters recorded on the DVD-Video, the first 10 seconds for each.

1. Touch the screen to display the menu, then touch the **[SUB]** key.
2. Touch the **[SCAN]** key, then touch the **[RTN]** key. The message "C.SCN" will be displayed.

After scan playback of all chapters on the disc, chapter scanning through the same disc is performed again.

Depending on the disc, the menu may appear again after scan playback of all chapters within the title.

3. Touch the **[C.SCN]** key to turn off the scan playback.

Repeat playback

This operation plays back chapters recorded on the DVD-Video repeatedly.

1. Touch the screen to display the menu, then touch the **[SUB]** key.
2. Touch the **[REPEAT]** key, then touch the **[RTN]** key. The message "C.RPT" will be displayed.
3. Touch the **[C.RPT]** key to turn off the repeat playback.

TOP function

The TOP function resets the DVD player to the first chapter of the track.

1. Press the **[BAND]** button to playback the first chapter(chapter No. 1).

Using the title menu

On DVD discs containing two or more titles, you can select from the title menu for playback.

1. Touch the screen and touch and hold the **[MENU]** key for 1 second or longer during playback.

The title menu screen appears.

- Depending on the disc, the title menu cannot be called.
2. Touch the **[KEY]** key, and touch the **[▲]**, **[▼]**, **[◀]** or **[▶]** key to select the item.
 - Depending on the disc, items cannot be selected with the ten-key buttons.
 3. Touch the **[ENT]** key.
 4. Touch the **[ESC]** key.

Switching among languages

On discs in which two or more audios or audio languages have been recorded, you can switch among the audio languages during playback.

1. Touch the screen to display the menu, then touch the **[SUB]** key.

2. Touch the **[AUDIO]** key during playback.

Each time you touch the key, you can switch among audio languages.

- Depending on the disc, up to 8 audios may be recorded. For details, see the mark of the disc (Ⓢ): Indicates that 8 audios have been recorded).
- When the power is turned on and when the disc is changed with a new one, the language set at the time of factory shipment is selected. If that language has not been recorded, the language specified on the disc.
- Depending on the disc, switching may be completely impossible or impossible on some scenes.
- It may take time to switch among audios.

Switching subtitles

On DVD discs in which two or more subtitle languages have been recorded, you can switch among the subtitle languages during playback.

1. Touch the screen to display the menu, then touch the **[SUB]** key.
2. Touch the **[SUB TITLE]** key during playback.

Each time you touch the key, you can switch among subtitles.

- Depending on the disc, up to 32 kinds of subtitles may be recorded. For details, see the mark of the disc (Ⓢ): Indicates that 8 kinds of subtitles have been recorded).
- Depending on the disc, switching may be completely impossible or impossible on some scenes.
- It may take time to switch among subtitles.

●To turn off subtitles

1. Touch the **[SUB TITLE]** key several times, and subtitles are turned off.

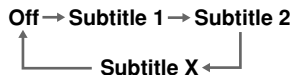

In initial setting:



Switching angles

On DVD discs in which video images have been recorded in two or more angles, you can switch among the angles during playback.

This operation can be performed when the “**Setting up the angle mark display**” function (see P. 33) is set to “**ON**”.

1. Touch the screen.
2. Touch the  (Angle mark) key during playback.
Each time you touch the key, you can switch among angles.
 - Depending on the disc, up to 9 angles may be recorded. For details, see the mark of the disc (: Indicates multi-angle).
 - Depending on the disc, angles may switch smoothly or switch with a momentary still image.
 - When the power is turned on and when the disc is changed with new one, the language set at the time of factory shipment is selected. If that language has not been recorded, the language specified on the disc.
 - Depending on the disc, switching may be completely impossible or impossible on some scenes.
 - It may take time to switch among angles.
 - Depending on the disc, scenes recorded in two or more angles may be played back.

Displaying the playback status

1. Touch the screen to display the menu, then touch the **[SUB]** key. Touch the **[P.TIME]** key during playback. Playback status is display on the screen.

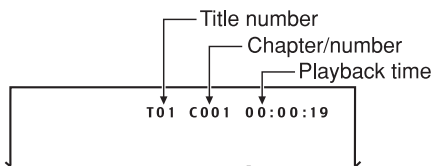

2. Touch the screen to turn off the display. The display will turn off after 7 seconds.

Watching a video CD

After disc loading, the play mode is automatically engaged.

- Button operation may not be allowed depending on the story of the disc.

■ After the menu screen is displayed

For V-CD discs equipped with the PBC (Play Back Control) function, the menu screen appears. After the menu screen is displayed, select an item in the following operations and play it back.

Showing the V-CD menu (for V-CD discs with PBC)

This key does not function on some discs.

1. Touch the screen to display the menu screen. Touch the **[MENU]** key during playback.

The V-CD menu appears.

The displayed contents may differ, depending on the V-CD software.

- Example showing menu display



2. To select the V-CD menu contents, touch the **[KEY]** key and use either the “**Cross KEY PAD**” or the “**Ten KEY PAD**” according to the disc contents menu.

Pausing playback

1. Press the **[▶/II]** button. Playback stops.
To resume playback, press the **[▶/II]** button, and playback resumes from the scene where playback is stopped.

DVD Video Player Operations

Slow playback

1. Press the [▶/||] button then press and hold the [▶▶] button.

While the button is being pressed, slow playback continues at the speed 1/3 times the normal playback.

- Slow playback cannot be performed in the backward direction. In addition, audio cannot be reproduced during slow playback.
- The same operation can be performed by touching the screen to display the menu screen, then touching the [◀◀] or [▶▶] key.

Skipping a track (searching)

1. Press the [◀◀] / [▶▶] button or touch the [◀◀] / [▶▶] key during playback.

The track is skipped and playback starts.

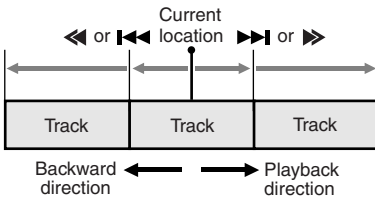

- Press the [▶▶] button, and playback starts from the beginning of the next track.
- Press the [◀◀] button, and playback starts from the beginning of the current track. When this button is pressed again within about 2 seconds, playback starts from the beginning of the previous track.
- The same operation can be performed by touching the screen to display the menu screen, then touching the [◀◀] or [▶▶] key.
- * In the case of some discs furnished with PBC function, when PBC is set to "ON", this operation will cause the menu screen to be displayed.

Fast forward and fast backward

1. Press and hold the [◀◀] or [▶▶] button during playback.

Press and hold the button, and the playback speed becomes 5-time faster first and then 20-time faster 3 seconds later. Release the button, and the normal speed is restored.

- The same operation can be performed by touching the screen to display the menu screen, then touching the [◀◀] or [▶▶] key.
- No audio is reproduced during fast forward and fast rewind operation.
- The unit may return to the menu screen when the button is pressed.

Searching with a track number

This operation allows searching with the track numbers recorded on the video CDs.

1. Touch the screen.
2. Touch the [SRCH] key.
3. Input the number of the track that you want to play back with [0] to [9] key.
4. Touch the [ENT] key.

Playback starts from the scene of the input track number.

- If the input track number does not exist or searching with a track number is not allowed, the screen image will not change.
 - * If you are playing a disc with PBC and the PBC function is engaged, this operation may not be performed.
5. Touch the [ESC] key.

Changing audio output

You can change the audio output method.

1. Touch the screen to display the menu, then touch the [SUB] key.
2. Touch the [AUDIO] key during playback. Each time you touch the key, you can switch among audio output methods.

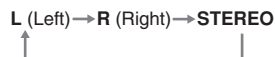

Displaying the playback status

1. Touch the screen to display the menu, then touch the [SUB] key.
2. Touch the [P.TIME] key.
Playback status is displayed on the screen.
3. Touch the screen to turn off the display. The display will turn off after 7 seconds.

On/off of Playback Control

* The factory default setting is "ON".

On video CDs equipped with Play Back Control function, you can turn it on/off.

1. Touch the screen to display the menu, then touch the [SUB] key.
2. Each time you touch the [PBC] key, you can switch between on and off.

When the PBC is turned on or off, the disc plays from the beginning.

● Playback control (PBC)

This control signal is recorded on a Video CD for version 2.0 and used to control playback. Using pre-recorded menu screens in the Video CD with PBC, you can enjoy playback of software with a simplified dialog function or software with search function. You can also enjoy a still picture at high or standard resolution.

Listening to a CD

* This unit is a CD TEXT compatible model.

This unit supports the display of the DISC TITLE, TRACK TITLE and ARTIST of the CD TEXT.

After disc loading, the play mode is automatically engaged.

Note:

• This unit supports only CD TEXT in English. Also, some character data may not be reproduced properly on the display.

Pausing playback

1. Press the [▶/||] button or touch the [▶/||] key during playback.
Playback pauses.
2. To resume playback, press the [▶/||] button or touch the [▶/||] key, and playback resumes.

Skipping a track (searching)

1. Press the [◀◀] or [▶▶] button during playback.

Tracks are skipped, as many as the times the button is pressed, and playback starts.

- Press the [▶▶] button, and playback starts from the beginning of the next track.
- Press the [◀◀] button, and playback starts from the beginning of the current track. When this button is pressed again within about 2 seconds, playback starts from the beginning of the previous track.
- The same operation can be performed by touching the screen to display the menu screen, then touching the [◀◀] or [▶▶] key.

TOP function

The TOP function resets the DVD player to the first track of the disc.

1. Press the [BAND] button to playback the first track (track No. 1).

Fast forward and fast backward

1. Press and hold the [◀◀] or [▶▶] button during playback.

Press and hold the button, and the playback speed becomes 5-time faster first and then 20-time faster 3 seconds later. Release the button, and the normal speed is restored.

Searching with a track number

This operation allows searching using the track numbers recorded on the CDs.

1. Touch the [SRCH] key.
2. Input the number of the track that you want to play back with [0] to [9] key.
3. Touch the [ENT] key.
Playback starts from the scene of the input track number.
 - If the input track number does not exist or searching with a track number is not allowed, the screen image will not change.
4. Touch the [ESC] key.

DVD Video Player Operations

Selecting a track on the LIST screen

This function allows you to select tracks from a displayed list.

1. Touch the [LIST] key.

The list menu will appear.

2. Press the [▲] or [▼] button to change the track display.
3. Touch the desired track title key.
The corresponding track will begin playback.
 - The titles will scroll when the selected track's "♪" mark is touched.
4. Press the [RTN] key to return to the previous screen.

Other various play functions

1. Touch the [SUB] key.



2. Touch the touch key of the function you want to play.

* [SCAN]; scan playback

This operation scans and plays back all tracks recorded on the disc, the first 10 seconds for each.

* [REPEAT]; repeat playback

This operation plays back tracks recorded on the CD repeatedly.

* [RANDOM]; random playback

This operation plays back all tracks on the disc in no particular order.

3. Touch the [RTN] key to return to the previous screen.



* Use to display current play status, and also as the cancel key.

4. To cancel play, touch the [T.SCN] ([T.RPT] or [T.RDM]) key.

Note:

- The scan playback function can also be performed using the title list screen's [T.SCN] key. To cancel play, touch the [T.SCN] key once again.

Displaying CD titles

This unit can display title data for CD-text CDs.

1. Touch the [DISC], [TRACK], or [ARTIST] key to cause the respective display to scroll once.

Listening to an MP3

This unit is a ID3 Tag compatible model.

This unit supports the title, artist and album display of the ID3 Tag versions 1 and 1.1.

After disc loading, the play mode is automatically engaged.

What is MP3?

MP3 is an audio compression method and classified into audio layer 3 of MPEG standards. This audio compression method has penetrated into PC users and become a standard format.

This MP3 features the original audio data compression to about 10 percent of its initial size with a high sound quality. This means that about 10 music CDs can be recorded on a CD-R disc or CD-RW disc to allow a long listening time without having to change CDs.

Note:

- Some CDs recorded on CD-R mode may not be usable.

Displaying MP3 ID3-TAG titles

ID3 information such as title, artist and album title can be displayed for an MP3 file containing ID3 Tag information.

Precautions when creating an MP3 disc

● File extensions

1. Always add a file extension ".MP3" or ".mp3" to an MP3 file by using single byte letters. If you add a file extension other than specified or forget to add the file extension ".MP3" or ".mp3", the file cannot be played. In addition, if you use upper case and lower case letters (capital and small letters) mixedly for file extensions, normal play may not be possible.
2. Files without MP3 data will not play.

DVD Video Player Operations

● Logical format (File system)

- When writing an MP3 file on a CD-R disc, please select “**ISO9660 level 1 or level 2 (without including expansion format)**” as the writing software format. Normal playback may not be possible if the disc is recorded on another format.
- The folder name and filename can be displayed as the title during MP3 play but the title must be within 31 and 27 single byte alphabetical letters and numerals for the folder name and filename, respectively (without including an extension). Entering more letters or numerals than specified may cause an incorrect display.

● Folder structure

- A disc with a folder having more than 8 hierarchical levels will conflict with the ISO9660 and playback will be impossible.

● Number of files or folders

- The maximum allowable number of folders is 255 (including root directory); the maximum allowable number of files is 512 (max. 255 per folder). This represents the maximum number of tracks that can be played back.
- Tracks are played in the order that they were recorded onto a disc. (Tracks might not always be played in the order displayed on the PC.)
 - Some noise may occur depending on the type of encoder software used while recording.
 - In case of a track recorded at VBR (variable bit rate), the display for the play time of the track may be slightly different from the actual play time. Also, the recommended value of VBR ranges from 64 kbps to 320 kbps.
 - Depending on the damage conditions of a file, it may occur that the file is not played and the next file is played instead. Also, if the damage is in a severe condition, play stops showing the “**ERROR 3**” display.

After disc selection, the play mode is automatically engaged.

Note:

- If ID3 Tag information was entered with 2-byte characters, it may occur that the characters are not reproduced properly on the display.

Regarding MP3 folder creation

Up to 8 folder levels (including the root directory) can be created for MP3 files (items ① – in the illustration). However, on this unit, folders created above the third level will be converted to 2 levels.

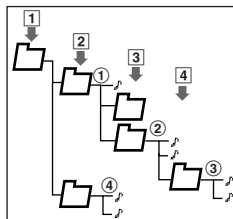

- Folders containing no MP3 files are not recognized.
- Only folders containing tracks (① to ④ in illustration) are given numbers and displayed on the list.

Pausing playback

- Press the [▶/||] button or touch the [▶/||] key during playback. Playback pauses.
- To resume playback, press the [▶/||] button or touch the [▶/||] key again, and playback resumes.

Skipping a track (searching)

- Press the [◀◀] or [▶▶] button during playback.

Tracks are skipped, as many as the times the button is pressed, and playback starts.

 - Press the [▶▶] button, and playback starts from the beginning of the next track.
 - Press the [◀◀] button, and playback starts from the beginning of the current track. When this button is pressed again within about 2 seconds, playback starts from the beginning of the previous track.

* This operation skips the track over the folder.

 - The same operation can be performed by touching the screen to display the menu screen, then touching the [◀◀] or [▶▶] key.

Fast forward and fast backward

- Press and hold the [◀◀] or [▶▶] button during playback.

Press the button, and the playback speed becomes 5-time faster first and then 20-time

DVD Video Player Operations

faster 3 seconds later. Release the button, and the normal speed is restored.

- The same operation can be performed by touching the screen to display the menu screen, then touching the [◀◀] or [▶▶] key.

Selecting a folder/track on the LIST screen

1. Touch the [LIST] key during playback. Folders (tracks) are displayed.
2. Touch the [▲] or [▼] key to select a folder and touch the folder name. The titles will scroll when the selected folder's "■" mark is touched. The track selection screen appears.
3. Touch the [▲] or [▼] key to select the track and touch the track name.
 - * When the selected track's "♪" mark is touched, the titles will scroll.
 Touch the [RTN] key to return to the folder select (LIST) screen.
4. Touch the [ESC] key.

Playback by selecting a folder and track (Direct select mode)

This operation allows searching using the folder and track numbers recorded on the MP3 disc.

1. Touch the [SRCH] key. Each time you touch the [SFT] key, you can switch between "T000" for track number input and "F000" for folder number input.
2. Input the number for the track or folder that you want to play back with [0] to [9] key.
3. Touch the [ENT] key. When you select the folder number playback starts from track 1 of the input folder number.
4. Touch the [ESC] key.

Other various play functions

1. Touch the [SUB] key.



2. Touch the touch key of the function you want to play.

- * **TRACK [SCAN]; track scan playback**
This operation scans and plays back all tracks recorded on the disc, the first 10 seconds for each.
 - * **FOLDER [SCAN]; folder scan playback**
This operation plays back the first tracks of all folder on the MP3 disc, the first 10 seconds for each.
 - * **TRACK [REPEAT]; track repeat playback**
This operation plays back the tracks currently being playback repeatedly.
 - * **FOLDER [REPEAT]; folder repeat playback**
This operation plays back tracks in an MP3 folder repeatedly.
 - * **TRACK [RANDOM]; track random playback**
This operation plays the tracks in the folder in a random order.
 - * **FOLDER [RANDOM]; folder random playback**
This operation plays back tracks recorded on the disc in no particular order.
3. Touch the [RTN] key, return to the previous screen.



- * Use to display current play status, and also as the cancel key.

4. To cancel play, touch the [T.SCN] ([F.SCN], [T.RPT], [F.RPT], [T.RDM] or [F.RDM]) key.

Notes:

- The scan playback function can also be performed using the title list screen's [T.SCN] key. To cancel play, press the [T.SCN] key once again.
- The folder playback function can also be performed using the title list screen's [F.SCN] key. To cancel play, press the [F.SCN] key once again.

TOP function

The TOP function resets the DVD player to the first track of the disc.

1. Press the [BAND] button to playback the first track (track No. 1).

iPod Operations

[▶/||] key

Use to control playback and pause.

[◀◀], [▶▶] keys

Use to perform track selection. Press continuously to enable fast-forward and fast-backward.

[SHUFFLE] key

Use to switch the shuffle mode, in the order Song Shuffle → All Shuffle → Shuffle OFF.

The default value is Shuffle OFF.

When enabled, this function performs playback of tracks in random order, regardless of the order in which they are recorded.

Note:

- The title display (*) shows, from top level down, the SONG title, ARTIST name, and ALBUM title. Press the operation display to scroll the SONG title.

● Operation display

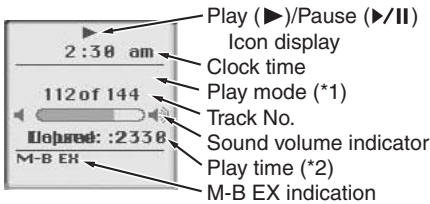

Notes:

*1 Displays status of Repeat, Shuffle play.

1 ↻ : 1-track Repeat

A ↻ : All Repeat

S ↻ : Shuffle

A ↻ : All Shuffle

*2 When operation display is touched, the display changes to show remaining playing time of current track; when pressed again the display returns to the normal play time display.

Selecting tracks by switching menus

1. Touch the iPod main menu's [BROWSE] key to display the BROWSE menu.

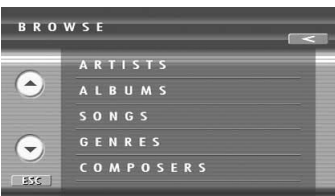

2. Touch the desired item key to display the corresponding list.
 3. Touch the desired track name to select.
 - The display contents will differ depending on the item key selected (**ARTISTS**, **ALBUMS**, **SONGS**, **GENRES**, **COMPOSERS**). The following is one example:
- If [ARTISTS] key is touched:
- ARTISTS list is displayed
 - ↓
 - Touch desired artist name
 - ALBUMS for that artist are displayed
 - ↓
 - Touch desired album name
 - SONGS on that album are displayed
 - ↓
 - Then touch the desired SONG title to select.

- When you return to the iPod main menu after selecting a track, the [BROWSE] key icon will turn to orange. If you touch the [BROWSE] key again in this condition, the song title list will be displayed directly.
- At a list display menu, touching the [◀] key will cause the display to go back one menu. Touching the [▼] key will cause the next menu to appear. Press the [▲] key to return to the original menu.
- Touching the [ESC] key will cause the display to return to the iPod main menu.
- Characters displayable on this unit include the following (in Unicode format):
 - [] (space), !, ", #, \$, %, &, ', (,), *, +, ,, -, ., /, 0, 1 to 9, :, ;, <, =, >, ?, @, A to Z,], ^, _ , ` , a to z, {, |, }, ~
- Attempting to input characters other than the above, or any format other than Unicode, will result in the display of question marks (?).

Selecting Tracks from a Play List

1. Touch the [PLAY LIST] key at the iPod main menu to display the play list menu.
2. Touch a desired play list name on the play list menu to display the corresponding list of tracks.
3. Touch the desired track name on the list to select.

Note:

- The titles on the list menu do not scroll.

VISUAL Operations

This function is available when a VTR, etc. is connected to the visual terminal.

WARNING

For your safety, the driver should not watch the VTR, etc. or operate the controls while driving. Please note that watching and operating the VTR, etc. while driving are prohibited by law in some countries.

Switching to the VISUAL mode

Note:

* For your safety, the VRX755VD has a safety function which turns off the picture when the car is moving, so only the audio can be heard. The picture can only be watched when the car is stopped and the parking break is applied.

1. Press the [SOURCE] button and select the VISUAL mode.

Changing the audio input level

The visual terminal can be used to change the input audio level.

* The factory default setting is "HIGH".

1. Touch the screen to display the menu, then touch the [SUB] key.
2. Touch the [VISUAL AUX SENS] key to select the level.

HIGH: 16.25 dB

MID: 3.75 dB

LOW: 0 dB

3. Touch the [ESC] key to return to previous screen.

CD Changer Operations

Note:

* When an optional DVD (CD) changer is connected through the CeNET cable, this unit controls all DVD (CD) changer functions. This unit can control a total of 2 changers (CD and/or DVD).

CD changer functions

Press the [SOURCE] button and select the CD changer mode to start play. If 2 CD changers are connected, press the [SOURCE] button to select the CD changer for play.

- * If "NO MAGAZINE" appears in the display, insert the magazine into the CD changer. "DISC CHECKING" appears in the display while the player loads (checks) the magazine.
- * If "NO DISC" appears in the display, eject the magazine and insert discs into each slot. Then, reinsert the magazine back into the CD changer.

CAUTION

CD-ROM discs cannot be played in the CD changer.

Pausing play

1. Press the [▶/||] button or touch the [▶/||] key to pause play. "PAUSE" appears in the display.
2. To resume play, press the [▶/||] button or touch the [▶/||] key again.

Switching the CD TEXT titles

This operation is only possible when this unit is connected with a CD TEXT compatible CD changer.

You can select the CD TEXT titles among the disc titles, track titles and artist titles.

When the panel is closed:

1. Press the [DISP] button to show the SUB display. The disc title, track title or artist titles, user title is displayed.
2. Each time you press and hold the [DISP] button for 1 second or longer, the display toggles among the disc title, the track title or the artist titles, user title.

The selected title scrolls once.

* When panel is open, titles will not be displayed on the information panel.

CD Changer Operations

When the panel is open:

1. Touch the [DISC], [TRACK], [ARTIST], or [USER] key to select the desired title.

The selected titles except for the user title scroll once.

Selecting a CD

When the panel is closed:

Each of the [DIRECT] buttons corresponds to a disc loaded into the magazine.

● Selecting a disc from 1 to 6

Press the corresponding [DIRECT] button (1 to 6) to select the desired disc.

● Selecting a disc from 7 to 12 (only when a 12 disc CD changer is used.)

Press the corresponding [DIRECT] button (1 to 6) for 1 second or more, then select the desired disc.

When the panel is open:

Each of the [DIRECT] keys corresponds to a disc loaded into the magazine.

● Selecting a disc from 1 to 6

1. Touch the [LIST] key.
2. Touch the corresponding [DIRECT] key (1 to 6) to select the desired disc.
The track selecting screen appears.
 - * When the "CD" mark of selecting disc is touched, the title will scroll.
3. Touch the [▲] or [▼] key to select the track and touch the track title.
 - * When the "♪" mark of selecting track is touched, the title will scroll.
4. Touch the [RTN] key to return to the track selecting screen.

● Selecting a disc from 7 to 12 (Only when a 12 disc CD changer is used.)

Touch the [▼] key.

Touch the corresponding [DIRECT] key (7 to 12) to select the desired disc.

Switching to a next disc. (Disc Up function)

The disc up function plays from the first track (track No.1) of the next disc.

Press the [BAND] button.

Each time you press the [BAND] button, the disc changes to the next disc.

Selecting with a track number

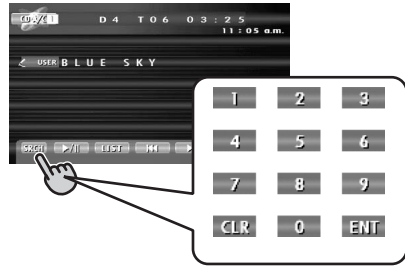

1. Touch the [SRCH] key.
2. Touch the [0] ~ [9] key corresponding with the track you desired. When you touch the wrong number ([0] ~ [9] key), you can cancel that to touch the [CLR] key.
3. Touch the [ENT] key.
The specified track is selected and playback starts.

Selecting a track

● Track-up

1. Press the [▶▶] button to move ahead to the beginning of the next track.
2. Each time you press the [▶▶] button, the track advances ahead to the beginning of the next track.
 - * When the panel is open, the same operation is also available by using the [▶▶] key.

● Track-down

1. Press the [◀◀] button to move back to the beginning of the current track.
2. Press the [◀◀] button twice to move to the beginning of the previous track.
 - * When the panel is open, the same operation is also available by using the [◀◀] key.

Fast-forward/Fast-backward

● Fast-forward

Press and hold the [▶▶] button for 1 second or longer.

- * When the panel is open, the same operation is also available by using the [▶▶] key.

● Fast-backward

Press and hold the [◀◀] button for 1 second or longer.

- * When the panel is open, the same operation is also available by using the [◀◀] key.

TOP function

The TOP function plays from the first track (track No. 1) of the disc.

● When playing a disc 1 to 6

Press the [DIRECT] button (1 to 6) with the same number as the CD playing.

● When playing a disc 7 to 12 (only when a 12 disc CD changer is used.)

Press the [DIRECT] button (1 to 6) with the same number as the CD playing for 1 second or longer.

Other various play functions

This function continues on the disc until it is cancelled or the mode is changed.

1. Touch the [SUB] key.



2. Touch the touch key of the function you want to play.

* TRACK [SCAN]; track scan playback

This scan play locates and plays the first 10 seconds of each track on a disc automatically.

* DISC [SCAN]; disc scan playback

This scan play locates and plays the first 10 seconds of the first track on each disc in the currently selected CD changer.

* TRACK [REPEAT]; track repeat playback

The repeat play continuously plays the current track.

* DISC [REPEAT]; disc repeat playback

After all tracks in the current disc have been played, the disc repeat play automatically replays the current disc over from the first track.

* TRACK [RANDOM]; track random playback

The random play selects and plays individual tracks on the disc in no particular order.

* DISC [RANDOM]; disc random playback

The disc random play selects and plays individual tracks or discs automatically in no particular order.

3. Touch the [RTN] key, return to the previous screen.



* Use to display current play status, and also as the cancel key.

4. To cancel play, touch the [T.SCN] ([D.SCN], [T.RPT], [D.RPT], [T.RDM] or [D.RDM]) key.

DVD Changer Operations

Only basic operations of DVD changer can be performed from the unit. Use the remote control unit to perform the following functions.

- SCAN, REPEAT, RANDOM function
- V-CD PBC function ON/OFF
- DVD SETUP function, AUDIO, SUBTITLE, ANGLE setting function

For details on operations other than those described below, see DVD player Operation. For details on DVD changer precautions, refer to the supplied owner's manual.

Note:

- When the DVD changer (VCZ625) is connected via optical cable, no sound will be output if AUDIO OUT is switched to ANALOG on the changer's "GENERAL SETUP" menu.

Selecting a disc

When the panel is closed :

Each of the [DIRECT] button corresponds to a disc loaded into the DVD changer.

Press the [DIRECT] button (1 to 6) and select the desired disc.

When the panel is open :

Touch the [LIST] key, otherwise press the [DISC SEL] button on the remote control unit.

Touch the [DIRECT] key (1 to 6) in the display or press the numeric button for the disc number (1 to 6) on the remote control unit to select the desired disc.

Switching to a next disc (Disc Up function)

The disc up function plays from the first track (track No.1) of the next disc.

Press the [BAND] button.

Each time you press the [BAND] button, the disc changes to the next disc.

- * When the remote control unit supplied with the DVD changer (VCZ625) is used to operate this component, some operation buttons are not supported.

TV Operations

TV functions

When an optional TV tuner is connected through the CeNET cable, this unit controls all TV tuner functions. To watch TV requires a TV tuner.

WARNING

For your safety, the driver should not watch the TV or operate the controls while driving. Please note that watching and operating the TV while driving are prohibited by law in some countries.

Watching TV

Note:

- For your safety, the VRX755VD has a safety function which turns off the picture when the car is moving, so only the audio can be heard. The picture can only be watched when the car is stopped and the parking break is applied.

1. Press the [SOURCE] button and select the TV mode.
2. Press the [BAND] button to select the desired TV band (TV1 or TV2). Each time the button is pressed, the input selection toggles between TV1 and TV2.
3. Press the [▶▶] or [◀◀] button to tune in the desired TV station.

- * When the panel is open, the same operation is also available by using the [◀◀◀] or [▶▶▶] key.

Watching a video

The TV tuner has a VTR input terminal to which 1 external device can be connected. Connect a 12V video cassette player (VCP) or video cassette recorder (VCR) to the TV tuner input terminal.

1. Touch the screen to display the menu, then touch the [SUB] key.
2. Touch the [EXTRA SELECT] key in the menu screen when the "VTR" is displayed.
3. To return to the TV broadcast, touch the screen again and touch the [EXTRA SELECT] key in the menu screen.

Seek tuning

1. Press the **[BAND]** button and select the desired TV band (TV1 or TV2).
 - * The same operation can be performed by touching the screen to display the menu screen, then touching the **[BAND]** key.
 - * If **"MANU"** is lit in the display, press and hold the **[BAND]** button for 1 second or longer. **"MANU"** in the display goes off and seek tuning is now available.
2. Press the **[>>]** or **[<<]** button to automatically seek a station. Press the **[>>]** button to automatically tune up the frequency band to the next available TV station; press the **[<<]** button to automatically tune down.
 - * The same operation can be performed by touching the screen to display the menu screen, then touching the **[<<<]** or **[>>>]** key.

Selecting with a station number

1. Touch the screen to display the menu, then touch the **[SRCH]** key.
2. Touch the **[0]~[9]** key corresponding with the station you desired. When you touch the wrong number (**[0]~[9]** key), you can cancel that to touch the **[CLR]** key.
3. Touch the **[ENT]** key. The radio station you required would be tuned.
4. Touch the **[ESC]** key.

Manual tuning

There are 2 ways available: Quick tuning and step tuning. When you are in the step tuning mode, the frequency changes one step at a time. In quick tuning mode, you can quickly tune the desired frequency.

1. Press the **[BAND]** button and select the desired band. (TV1 or TV2)
 - * The same operation can be performed by touching the screen to display the menu screen, then touching the **[BAND]** key.
 - * If **"MANU"** is not lit in the display, press and hold the **[BAND]** button for 1 second or longer. **"MANU"** appears in the display and manual tuning is now available.
2. Tune into a station.

●Quick tuning:

Press and hold the **[>>]** or **[<<]** button for 1 second or longer to tune in a station.

●Step tuning:

Press the **[>>]** or **[<<]** button to manually tune in a station.

Notes:

- The same operation can be performed by touching the screen to display the menu screen, then touching the **[<<<]** or **[>>>]** key.
- Manual tuning is cancelled if you do not operate the unit for 7 seconds longer. (*Only when connecting the TTX7503Z or TTX7504Z with this unit)

Recalling a preset station

A total of 12 TV stations can be stored (6-TV1 and 6-TV2). This allows you to select your favorite TV stations and store them in memory for later recall.

There are 2 ways available to recall the preset station.

●Using the [DIRECT] button

1. Press the **[BAND]** button and select the desired TV band. (TV1 or TV2)
2. To recall a stored TV station, press the desired **[DIRECT]** button to select that station.
 - * Press and hold one of the **[DIRECT]** buttons for 2 seconds or longer to store the current station into the preset memory.

●Using the LIST screen

1. Touch the screen to display the menu, then touch the **[LIST]** key.
2. Touch the corresponding **[DIRECT]** key to recall the stored station.
 - * You can select the desired band to touch the **[BAND]** key.
 - * Touch and hold one of the **[DIRECT]** key for 2 seconds or longer to store the current station into the preset memory.
3. Touch the **[RTN]** key to return to the previous mode.

Manual memory

●Using the [DIRECT] button

1. Select the desired station with seek tuning, manual tuning or preset tuning.
2. Press and hold one of the **[DIRECT]** buttons for 2 seconds or longer to store the current station to that preset memory.

●Using the LIST screen

1. Press the **[BAND]** button and select the desired TV band. (TV1 or TV2)

TV Operations

2. Touch the screen to display the menu, then touch the **[LIST]** key.
3. Touch and hold one of the **[DIRECT]** key for 2 seconds or longer to store the current station into the preset memory.

Auto store

Auto store selects 6 TV stations automatically and stores each one into a preset memory.

If there are not 6 stations with good reception, stations previously stored in memory remain and only the strong stations are stored into memory.

1. Press the **[BAND]** button and select the desired TV band. (TV1 or TV2)
2. Touch the screen to display the menu, then touch **[LIST]** key.
3. Touch and hold the **[AS]** key for 2 seconds or longer. The stations with good reception are stored automatically to the preset channels.

Preset scan

Preset scan allows the user to view each preset position before it automatically advances to the next preset. This function is useful for searching for desired TV station in memory.

1. Touch the screen to display the menu, then touch **[LIST]** key.
2. Touch the **[PS]** key to start preset scan. The unit starts scanning each station for 7 seconds sequentially.
3. When the desired channel is received, touch the **[PS]** key again.

Setting the TV diver

* This function is enabled only when the panel is open.

* Normally use the TV diver with the "ON" position. You can change the reception setting for the TV antenna connected to the TV tuner.

1. Touch the screen to display the menu, then touch **[SUB]** key.
2. Touch the **[TV DIVER]** key to set the selected reception setting.

● ON:

Sets reception emphasizing the visual.

● OFF:

Sets the diver setting to OFF.

3. Touch the **[RTN]** key to return to the previous mode.

SIRIUS Operation

What is Sirius Satellite Radio?



Sirius is radio the way it was meant to be: Up to 100 new channels of digital quality programming delivered to listeners coast to coast via satellite.

That means 50 channels of completely commercial-free music. Plus up to 50 more channels of news, sports, and entertainment from names like CNBC, Discovery, SCI-FI Channel, A&E, House of Blues, E!, NPR, Speedvision and ESPN.

Sirius is live, dynamic entertainment, completely focused on listeners. Every minute of every day of every week will be different. All 50 commercial-free music channels are created in-house and hosted by DJs who know and love the music. Do you like Reggae? How about Classic Rock or New Rock? Sirius has an array of choices spanning a vast range of musical tastes including the hits of the 50's, 60's, 70's, & 80's as well as Jazz, Country, Blues, Pop, Rap, R&B, Bluegrass, Alternative, Classical, Heavy Metal, Dance and many others...

From its state-of-the-art, digital broadcasting facility in Rockefeller Center, New York City, Sirius will deliver the broadest, deepest mix of radio entertainment from coast to coast.

Sirius will bring you music and entertainment programming that is simply not available on traditional radio in any market across the country. It's radio like you've never heard before.

So Get Sirius and Listen Up! For more information, visit siriusradio.com.

Selecting Sirius Radio modes

Press the **[SOURCE]** button to select the Sirius mode.

The Sirius indication lights entering the mode that was engaged when the unit was turned off last time.

Selecting a band

Press the [BAND] button to select a band.

Each press of the button changes the display as shown below.

SR1 → SR2 → SR3 → SR1 ...

● Information displayed during reception

The following information is displayed when Sirius Radio cannot be received normally.

- **UPDATING** : when the receiver is turned on the first time or after a reset
- **ACQUIRING** : when a channel is being tuned in (no signal is yet received)
- **INVALID CH** : a channel without a broadcast has been selected
- **NO SIGN-UP** : a channel not covered by your contract

Switching displayed channel labels

● Panel closed

1. Press the [DISP] button to show the sub display.
2. Hold down the [DISP] button for 1 second to sequence the displayed channel labels as shown below.

CH.NAME → TITLE → ARTIST → RADIO
TEXT → CH. NAME...

● Panel open

CH.NAME, CATEGORY TITLE, ARTIST and RADIO TEXT are displayed.

Touch each keys, the selected labels scroll once.



Displaying radio text

* Radio text is only displayed for stations that transmit such information.

Touch the screen in the main screen to display radio text.

Selecting with a station number

1. Touch the [SRCH] key.
2. Touch the [0]~[9] key corresponding with the station you desired. When you touch the wrong number ([0]~[9] key), you can cancel that to touch the [CLR] key.
3. Touch the [ENT] key. The radio channel you required would be tuned.
4. Touch the [ESC] key.

Channel selection

Channels are selected with the following buttons.

- The [◀] or [▶] button
- A [DIRECT] button

* For details, see the following operation descriptions.

Note:

- The audio output is muted and other button operations are not accepted during channel selection.

Tuning mode (T-MODE)

There are two channel selection modes: seek mode and manual mode.

● Seek tuning

Only channels that can be received are selected while channels without broadcasts and channels not covered by the contract are automatically skipped.

1. Press the [◀] or [▶] button.
The receiver seeks the next available channel below or above the current channel.

* The same operation can be performed by touching the screen to display the menu screen, then touching the [◀◀] or [▶▶] key.

2. Press and hold the [◀] or [▶] button.
The receiver moves to seek channels below or above the current channel. If the channel found when either button is released is available, that channel is received. Otherwise, seeking continues until an available channel is found.

● Manual tuning

Any channel including channels without broadcasts and channels not covered by the contract can be selected during manual tuning.

1. Press and hold the [BAND] button or the [BAND] key for 1 second or longer.

SIRIUS Operation

- * This changes the seek mode to manual mode and the "MANU" indicator on the display lights. When this operation is performed in manual mode, the seek mode is engaged and the "MANU" indicator on the display goes off.

Note:

- The receiver automatically reverts to the seek mode when the [◀◀] or [▶▶] button is not used for 7 seconds in the manual mode.
2. Press the [◀◀] or [▶▶] button. The receiver moves to channels above or below the current channel one by one.
 - * The same operation can be performed by touching the screen to display the menu screen, then touching the [◀◀] or [▶▶] key.
 3. Press and hold the [◀◀] or [▶▶] button for 1 second or longer. The receiver moves to seek channels below or above the current channel and the channel found when either button is released is received.

Recalling a preset station

A total of 18 SIRIUS stations can be stored (6-SR1, 6-SR2 and 6-SR3). This allows you to select your favorite SIRIUS stations and store them in memory for later recall.

● Using the LIST screen

1. Touch the [LIST] key.
2. Press the [BAND] button or touch the [BAND] key to select the desired band.
3. Touch the [DIRECT] key (1 to 6) to select the desired preset station.

- * Touch and hold the [DIRECT] key for 2 seconds or longer to store the current station into preset memory.

4. Touch the [RTN] key to return to the previous mode.

● Using the [DIRECT] button

1. Press the [BAND] button and select the desired SIRIUS band (SR1, SR2 or SR3).
2. To recall a stored SIRIUS station, press the desired [DIRECT] button to select that station.
 - * Press and hold one of the [DIRECT] buttons for 2 seconds or longer to store the current station into preset memory.

Manual memory

1. Select the desired station with seek tuning, manual tuning or preset tuning.
2. Press and hold one of [DIRECT] buttons for 2 seconds or longer to store the current station into preset memory.

Notes:

- When the name of a channel stored in memory is changed by a broadcasting station, the display may show a channel name that differs from the stored name.
- A channel stored in memory may be discontinued at the option of the broadcasting station.

Category selection function

SIRIUS Radio allows you to select broadcast channel category (contents).

Receiving stations selected by category

1. Touch the [SUB] key.

● Selecting from preset categories

- 1-1. Touch the [PRESET] key and select a category by touching a [DIRECT] key (1 to 6) storing the desired category.

● Selecting by displaying all categories

- 1-1. Touch the [ITEM] key to display a category.
- 1-2. Touch the [▼] or [▲] on the screen to select the desired category on the screen.
- 1-3. Select by touching a [DIRECT] key (1 to 6).
2. Press the [◀◀] / [▶▶] button or touch the [◀◀] / [▶▶] key to tune in a station. This starts seek tuning and broadcast channels that meet the specified category are selected.

Notes:

- When the category selection mode is entered, the category of the last received channel is displayed first.
- The category selection mode is canceled when no channel with the selected category can be found.
- Press the [◀◀] or [▶▶] button within 7 seconds after a channel has been set to continue seeking channels up or down. The category selection mode is canceled and normal reception is resumed if no operation is performed for 7 seconds.

SIRIUS Operation

Presetting a category

A category can be preset by registering specific categories in [DIRECT] keys 1 to 6. Then the desired category can be recalled by pressing the corresponding [DIRECT] keys.

1. Touch the [SUB] key.
2. Touch the [ITEM] key to display a category.
3. Touch the [▼] or [▲] on the screen to select the desired category on the screen.
4. Touch the category you wish to store in memory.
5. Touch the [PRESET] key to open the preset screen.
6. Touch and hold down for 2 seconds or longer the Preset No. key you wish to store in memory.

Notes:

- When the name of a channel stored in memory is changed by a broadcasting station, the display may show a channel name that differs from the stored name.
- A channel stored in memory may be discontinued at the option of the broadcasting station.

Scan function

There are two scan modes: a category scan mode and a preset scan mode.

During scanning channels are displayed in abbreviated form and the display mode cannot be switched.

● Category scanning

In a category scan, broadcast channels in the same category as the current channel are selected about every 10 seconds.

1. Touch the [SUB] key.
2. Touch the [SCAN] key.

Note:

- Category scanning is not available when no category is defined for the current channel.

● Preset scan

A preset scan scans the channels (up to 18 channels) stored in the preset memory about every 10 seconds.

1. Touch the [LIST] key.
2. Touch the [PS] key.

Other Functions

Entering titles

Titles up to 10 characters long can be stored in memory and displayed for Radio stations, CD, TV stations and CD changer. The numbers of titles that can be entered for each mode are as follows.

Mode	Number of titles
TUNER mode	30 titles
CD mode	50 titles
TV mode	15 titles

CD changer mode	Number of titles
CDC655Tz connected	100 titles
DCZ625 connected	100 titles

* You cannot enter titles with the unit in Seek, Preset Scan, Auto store (TUNER or TV) mode. Cancel each of those operations before entering titles.

1. Press the [SOURCE] button to select the mode you want to enter a title (TUNER, CD, CD-changer or TV).
 2. Select and play a CD in the CD changer or a CD track or tune in to a Radio station or a TV station for which you want to enter the title.
 3. Touch the screen (TV mode only).
 4. Touch the [LIST] key to display the LIST screen.
 5. Touch the [USER TTL] key.
The title input mode display appears.
 6. Touch the characters, symbols, etc. shown in the display to input titles.
 - “→←” : Centering
 - “CLEAR” : Backspace
 - “□” : Space
 - “MEMO” : Memory
 - “▼(▲)” : Scroll
- Notes:**
- Up to 10 characters can be input.
 - To switch the character types, touch the scroll key (▼) at the lower left of the display.
7. Repeat the step 6 to enter the complete title.
 8. Touch the [MEMO] key for 2 seconds or longer to store the title into memory and cancel title input mode.

Other Functions

Title list play

You can display a list of titles, then select the CD track, disc or broadcast station to listen to from that list.

* You can not display a title list with the unit in Seek, Preset Scan, Auto store (Tuner or TV) mode. Cancel those operation modes before to display a title list.

1. Touch the screen (TV mode only).
2. Touch the [LIST] key to display the LIST screen.

A title list is displayed. The following functions can be carried out in a title list display.

- **TUNER:** A title of a station stored in the presets 1 to 6 or frequency is displayed;
 - **CD-changer:** DISC titles for discs 1 to 6 are displayed (By changing over a display page in case of 12-CD changer, disc 7 to 12 can be displayed). When there is not any disc in a changer, "NO DISC" is displayed.
 - **TV/SIRIUS:** A title of a channel stored in the presets 1 to 6 or a channel number is displayed.
3. Touch the [DIRECT] key (1 to 6) to select one of the items 1 to 6 and reproduce the selected broadcast station or disc.
 - * In case of 12-CD changer, touch the [▼] key to change over to a list display of discs 7 to 12.
 4. Touch the [RTN] key again to return to the previous mode.

Changing over monitor display size

* This function is available only when the panel is open.

Notes:

- This function is not available while you are driving.
- Switch to the VISUAL/DVD player(DVD video or video CD)/DVD changer/TV mode you see.

1. Touch the screen to display the menu, then touch "display size" key ([F.WIDE], etc.). Each time you press the [DISP] button, the monitor display size changes in the following order:

"F. WIDE" → "CINEMA" → "NORMAL" → "WIDE" → "F. WIDE"

- "F. WIDE": (full wide mode)

The whole image elongates horizontally.

- "CINEMA": (cinema mode)

The image at both top and bottom in a display disappears.

- "NORMAL": (normal display)

There is a black area at both right and left ends of a display. In case of normal TV broadcasting (4:3), the image can be shown without being cut or deformed.

- "WIDE": (wide mode)

The image at right and left ends in a display elongates horizontally.

Notes:

- When a normal 4:3 size image, not being a wide one, is viewed by displaying it fully on a wide monitor display in a wide mode or a full-wide mode, a part of the peripheral image will be lacking or deformed. In deference to the intention of producer, an original image can be viewed in a normal mode.
- During superimposed display, it becomes a full-wide mode.
- When the monitor display size mode is changed, only the monitor display size indication superimposed on the screen ("NORMAL", "WIDE", "F.WIDE" or "CINEMA") will be changed, then the corresponding display size mode will be engaged.

Internal amplifier cancel function

This function is used to disable the internal amplifier when an external amplifier is connected.

* The factory default setting is "OFF".

1. Press the [ADJ] button.
2. Touch the [AUDIO EXT.] key.
3. Touch the [AMP CANCEL] key to select "ON" or "OFF".
 - **OFF:** Use with the internal amplifier.
 - **ON:** Use with the external amplifier.
4. Touch the [ESC] key to return to the previous screen.

Triggered audio mute for cellular telephones

This unit requires special wiring to mute the audio signal automatically when a cellular telephone rings in the car.

* This function is not compatible with all cellular telephones. Contact your local authorized Clarion dealer for information on proper installation and compatibility.

5.1 ch Surround Decoder Operations

5.1 ch Surround Decoder control function

This function is available when a 5.1 ch Surround Decoder (DVH940) is connected.

When the 5.1 ch Surround Decoder (DVH940, sold separately) is CeNET connected, the 5.1 ch Surround Decoder Control unit (DVC940, sold separately) cannot be used.

This section describes operation procedures only.

For other details, refer to the owner's manual supplied with the 5.1 ch Surround Decoder.

* For details on functions of each mode, refer to the owner's manual supplied with the DVH940.

* Requires an optional amplifier sold separately.

Note:

• The 2-ZONE mode is disabled when the DVH940 is connected.

1. Press the [ADJ] button to show the ADJUST MODE menu.

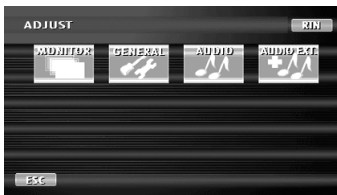

2. Touch the [AUDIO EXT.] key.



3. Touch the required keys to make the desired setting.

● SPEAKER SEL (speaker selection)

This function determines center speaker, surround speaker and sub woofer connection.

- 3-1. Touch the [SPEAKER SEL] key to show the submenu.
- 3-2. Touch the [CENTER SP], [SURROUND SP] or [SUB WOOFER] key to turn speakers on or off depending on what speakers are connected.

- The factory default setting is "ON".
- The phase of the "SUB WOOFER" is reversed in the ON- setting. The default value is "ON+".

● Dolby PL II CONTROL

* This function is available only when the MUSIC MODE is selected for Dolby PL II. For setup details, see "Selecting the Dolby PL II (Dolby Pro Logic II) type."

- 3-1. Touch the [Dolby PL II CONTROL] key to show the submenu.
- 3-2. Touch the [PANORAMA], [DIMENSION] or [CENTER WIDTH] key to select respective item.

[PANORAMA]:

Select the "ON" or "OFF". "OFF" is the default value.

[DIMENSION]:

Touch the key to make adjustments between 0 and 6. The default value is "3".

[CENTER WIDTH]:

Touch the key to make adjustments between 0 and 7. The default value is "3".

● FILTER

This function is used to select filter frequencies that suit the speakers that are used.

* This function is not available for speakers whose SPEAKER SEL setting is set to OFF.

- 3-1. Touch the [FILTER] key to show the submenu.
- 3-2. Touch the [FRONT HPF], [CENTER HPF], [SURROUND HPF] or [SUB WOOFER LPF] key to set respective item.

[FRONT HPF]:

This function can be set to the following four settings: 50 Hz, 80 Hz, 120 Hz or THRGH (through). "THRGH" is the default value.

[CENTER HPF]:

This function can be set to the following three settings: 50 Hz, 80 Hz and 120 Hz. "120 Hz" is the default value.

[SURROUND HPF]:

This function can be set to the following four settings: 50 Hz, 80 Hz, 120 Hz or THRGH (through). "THRGH" is the default value.

[SUB WOOFER LPF]:

This function can be set to the following three settings: 50 Hz, 80 Hz and 120 Hz. "120 Hz" is the default value.

5.1 ch Surround Decoder Operations

● SPEAKER GAIN

This function sets speaker output level.

* This function is not available for speakers whose SPEAKER SEL setting is set to OFF.

- 3-1. Touch the [**SPEAKER GAIN**] key to show the submenu.
- 3-2. Touch the [**FRONT L**], [**CENTER**], [**FRONT R**], [**SURROUND R**], [**SURROUND L**] or [**SUB WOOFER**] key to set respective item.
- 3-3. Touch the key to make adjustments in the range -10 dB to +10 dB in 1 dB step increments. The default value is "0 dB".

● DELAY

This function adjusts the timing of the speakers so that they are synchronized with front speaker output.

* This function is not available for speakers whose "SPEAKER SEL" setting is set to OFF.

- 3-1. Touch the [**DELAY**] key to show the submenu.
- 3-2. Touch the [**CENTER SP**] or [**SURROUND SP**] key to set respective item.
 - [**CENTER SP**]:
Adjustments are made in the range 0 ms to 5 ms. The default value is "0 ms".
 - [**SURROUND SP**]:
Adjustments are made in the range 0 ms to 15 ms. The default value is "0 ms".

● DRC

This function sets the dynamic range compression.

* This function is not available for speakers whose "SPEAKER SEL" setting is set to OFF.

- 3-1. Touch the [**DRC**] key to show the submenu.
- 3-2. Touch the [**MAX**], [**STD**] or [**MIN**] key to select respective item.
 - *The default value is [**MAX**].
4. Touch the [**RTN**] key, [**ESC**] key, or press the [**ADJ**] button.

DSF mode

DSF effect ON/OFF

* The factory default setting is "OFF".

1. Press the [**ADJ**] button and touch the [**AUDIO**] key.



2. Touch the [**STATUS**] key.
3. Touch the [**DSF**] key to select "ON" and "OFF".
4. Each time the [**DSF**] key is touched, the on and off statuses are switched alternately.
5. Touch the [**RTN**] key, [**ESC**] key, or press the [**ADJ**] button.

Note:

- If the DSF effect is set to OFF, the adjustment made in "DSF" is not reflected in the music source.

Selecting the DSF type

1. Press the [**ADJ**] button and touch the [**AUDIO**] key.
2. Touch the key for the desirable type to select it.
3. Touch the [**RTN**] key, [**ESC**] key, or press the [**ADJ**] button.

P.EQ mode

P.EQ effect ON/OFF

* The factory default setting is "OFF".

1. Press the [**ADJ**] button and touch the [**AUDIO**] key.
2. Touch the [**STATUS**] key.
3. Touch the [**P.EQ**] key to select "ON" and "OFF".
4. Each time the [**P.EQ**] key is touched, the on and off statuses are switched alternately.
5. Touch the [**RTN**] key, [**ESC**] key, or press the [**ADJ**] button.

Note:

- If the P.EQ effect is set to OFF, the adjustment made in "P.EQ" is not reflected in the music source.

5.1 ch Surround Decoder Operations

Setting and storing P.EQ Properties

1. Press the [ADJ] button and touch the [AUDIO] key.
2. Touch the [P.EQ] key to show the P.EQ adjusting display.
3. Touch the key for the desirable type to select it. The P.EQ adjustment contents are as follows:

●SIGNAL

- * The factory default setting is "P.NOISE".

This function selects "P. NOISE" or "MUSIC".

●SPEAKER SELECT

- * The factory default setting is "FRONT".

This function selects "FRONT", "CENTER" or "SURROUND".

●BAND

- * The factory default setting is "BAND1".

Select the channel to be compensated ("BAND1", "BAND2", "BAND3").

●FREQUENCY

- * The factory default setting is "1 kHz".

Select the center frequency that you want to compensate from the range of 18 Hz to 20 kHz. (1/3 octave step, 31 points)

●Q

- * The factory default setting is "1".

Set the sharpness of the Q-curve to one of the parameters: 1, 3, 5, 7 and 20.

●GAIN

- * The factory default setting is "0".

Adjust the gain (output level) in the range of -6 dB to +6 dB. (1 dB step, 13 points)

4. Touch the [RTN] key, [ESC] key, or press the [ADJ] button.

Selecting the Dolby PLII (Dolby Pro Logic II) type

- * The factory default setting is "OFF".

1. Press the [ADJ] button and touch the [AUDIO] key. Touch the [Dolby PLII] key.
2. Touch the key for the desirable type to select it.
3. When the setting is finished, touch the [ESC] key or press the [ADJ] button to return to the previous mode.

Output adjustment of subwoofer volume, center volume and balance/fader

1. Press the [ADJ] button and touch the [AUDIO] key.

Touch the [DETAIL] key.

2. To make an adjustment on :

●Subwoofer volume adjustment

- 2-1. Touch the [SUBWOOFER VOL] key to adjust to desirable level.

- * The factory default setting is "0". (Setting range : -6 to 3)

●Center volume adjustment

- 2-1. Touch the [CENTER VOL] key to adjust to desirable level.

- * The factory default is "0". (Setting range : -6 to 0)

●Balance/Fader adjustment

- 2-1. Touch the [BAL/FAD] key.

Touch the [▲] or [▼] key to adjust the balance level.

[▲] key : emphasized the sound from the front speakers.

[▼] key : emphasized the sound from the rear speakers.

- 2-2. Touch the [◀] or [▶] key to adjust the fader level.

[◀] key : emphasized the sound from the left speakers.

[▶] key : emphasized the sound from the right speakers.

3. Touch the [RTN] key, [ESC] key, or press the [ADJ] button.

12. IN CASE OF DIFFICULTY

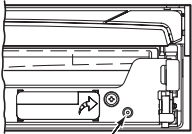
	Problem	Cause	Measure
GENERAL	Power does not turn on. (No sound is produced.)	Fuse is blown.	Replace with a fuse of the same amperage. If the fuse blows again, consult your store of purchase.
		Incorrect wiring.	Consult your store of purchase.
	Nothing happens when buttons are pressed. Display is not accurate.	The microprocessor has malfunctioned due to noise, etc.	Turn off the power and remove the DCP. Press the reset button for about 2 seconds with a thin rod. Note: <i>When the reset button is pressed, turn off the ACC power.</i>
			 <p>The Reset button</p> <p>* When the reset button is pressed, frequencies of TV/radio stations, titles, etc. stored in memory are cleared.</p>
The remote controller does not work.	Direct rays of the sun fall on the light-receptive part of the remote controller.	When direct rays of the sun fall on the light-receptive part of the remote controller, it may not work.	
	The batteries of the remote controller unit are dead or there is no battery in the remote controller unit.	Check the batteries of the remote controller unit.	
DVD Player	Disc cannot be loaded.	Another disc is already loaded.	Eject the disc before loading the new one.
		There is a foreign matter already in place.	Eject the foreign matter forcibly.
	Sound skips or is noisy.	Compact disc is dirty.	Clean the compact disc with a soft cloth.
		Compact disc is heavily scratched or warped.	Replace with a compact disc with no scratches.
	Sound is bad directly after power is turned on.	Water droplets may form on the internal lens when the car is parked in a humid place.	Let dry for about 1 hour with the power on.
Disc cannot play with the display "PARENTAL VIOLATION" shown.	The view is limited.	Release the view limitation or change the parental level. See the subsection "Setting up the parental level".	

	Problem	Cause	Measure
TV	The image is not displayed.	The parking brake is not pulled.	Check that the parking brake is applied.
	The display is dark.	The brightness control is too low.	Adjust the brightness properly.
		The operating condition is not good.	The temperature inside the vehicle may be 0°C or less. Set to an appropriate temperature (25°C or so) and check it again.
		The headlight of the vehicle is lit.	The display is made dark at night to prevent the glare (When the headlight of the vehicle is lit in the daytime, the display gets dark).
	The color of the display is light or a shade of color is not good.	The color is not adjusted adequately.	Check that COL and HUE are adjusted properly.
	When the VTR is connected, the image is disturbed.	Improper NTSC/PAL setting	Set the NTSC/PAL properly according to the VTR.
	When the TV tuner is connected, the image gets unclear.	Bad receiving condition	A radio wave may not reach sufficiently due to obstruction of mountains or buildings. Check it again at a place where a radio wave can be received properly.
	The TV tuner has a double or triple image.	Bad receiving condition	It may be under the influence of radio wave reflected by mountains or buildings. Check it again after changing place or direction.
The TV tuner has spots or stripes in the image.	Presence of jamming	It may be under the influence from automobiles, streetcar, power cable, neon sign, and so forth. Check it again after changing place.	
There are red, green, and blue points in the display.	_____	This is not a failure, but a phenomenon peculiar to a liquid crystal panel (The liquid crystal panel is produced according to technology with very high precision. Note that, though there are effective pixels of 99.99% or more, pixel missing or normally lit pixels account for 0.01%).	

13. ERROR DISPLAYS

If an error occurs, one of the following displays is displayed.

Take the measures described below to eliminate the problem.

		Cause	Measure
DVD PLAYER	ERROR 2	A CD is caught inside the CD deck and is not ejected.	This is a failure of CD deck's mechanism and consult your store of purchase.
	ERROR 3	A CD cannot be played due to scratches, etc.	Replace with a non-scratched, non-warped-disc.
	ERROR 6	A CD is loaded upside-down inside the CD deck and does not play.	Eject the disc then reload it properly.
	DISC ERROR	A PAL format disc has been loaded.	Remove the disc and replace with an NTSC format disc.
CD CHANGER	ERROR 2	A CD inside the CD changer is not loaded.	This is a failure of CD changer's mechanism and consult your store of purchase.
	ERROR 3	A CD inside the CD changer cannot be played due to scratches, etc.	Replace with a non-scratched, non-warped-disc.
	ERROR 6	A CD inside the CD changer cannot be played because it is loaded upside-down.	Eject the disc then reload it properly.

For the DVD changer, refer to the Owner's Manual provided with the DVD changer.

If an error display other than the ones described above appears, press the RESET button. If the problem persists, turn off the power and consult your store of purchase.

* When the reset button is pressed, frequencies of TV/radio stations, titles, etc. stored in memory are cleared.

14. SPECIFICATIONS

FM Tuner

Frequency Range: 87.9 MHz to 107.9 MHz
Usable Sensitivity: 9 dBf
50dB Quieting Sensitivity: 15 dBf
Alternate Channel Selectivity: 70 dB
Stereo Separation (1 kHz): 35 dB
Frequency Response (± 3 dB): 30 Hz to 15 kHz

AM Tuner

Frequency Range: 530 kHz to 1710 kHz
Usable Sensitivity: 28 dB μ V

DVD player

System:
Digital Versatile Disc System with CDDA capable
Usable discs: DVD video disc, Compact disc
Frequency Response:
20Hz to 20 kHz (CD) (± 1 dB)
Signal to Noise Ratio: 100 dB (1 kHz) IHF-A
Dynamic Range: 100 dB (1 kHz)
Distortion: 0.01%

Audio Amplifier

Rated power output:
18 W \times 4 (20 Hz to 20 kHz, 1%, 4 Ω)
Maximum power output:
212 W (53 W \times 4)
Speaker impedance: 4 Ω (4 to 8 Ω)

Input

Audio input:
130 \pm 60mVrms (High)
600 \pm 80mVrms (Mid)
840 \pm 100mVrms (Low)
(input impedance 10 k Ω or greater)

Video input:
1.0 \pm 0.2 Vp-p (input impedance 75 Ω)

Video output

Video output:
1.0 \pm 0.2 Vp-p (output impedance 75 Ω)

LCD Monitor

Screen Size: 7-inch wide type
6" Width (152 mm) \times 3-5/16" Height (85 mm)
Display method:
Transmission type TN liquid crystal display
Drive method: TFT (thin-film transistor) active matrix driving
Pixels: 336,960 (1440 \times 234)

General

Power source voltage:
14.4 V DC (10.8 to 15.6 V allowable)
Ground: Negative
Current consumption: 4.0 A (1 W)
Auto Antenna Rated Current: 500 mA less
Dimensions of the Main Unit:
7" Width (178 mm) \times 1-15/16" Height (50 mm) \times 6-1/2" Depth (165 mm)
Weight of the Main Unit: 2.4 kg
Dimensions of the Remote Control Unit:
2-1/8" Width (54 mm) \times 1-1/8" Height (28.8 mm) \times 6-1/8" Depth (155 mm)
Weight of the Remote Control Unit:
100 g (including battery)

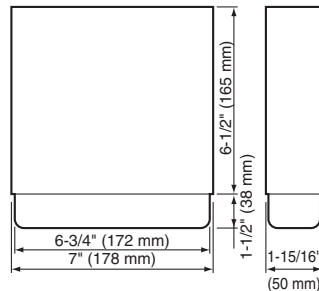

Notes:

- Specifications comply with JEITA Standards.
- Specifications and design are subject to change without notice for further improvement.

■ Contents

1. BEFORE STARTING	65
2. PACKAGE CONTENTS	65
3. GENERAL CAUTIONS	66
4. CAUTIONS ON INSTALLATION	66
5. INSTALLING THE MAIN UNIT	67
6. REMOVING THE MAIN UNIT	69
7. CAUTIONS ON WIRING	69
8. WIRE CONNECTION	70
9. SAMPLE SYSTEMS	73

1. BEFORE STARTING

1. This set is exclusively for use in cars with a negative ground 12 V power supply.
2. Read these instructions carefully.
3. Be sure to disconnect the battery “⊖” terminal before starting. This is to prevent short circuits during installation. (Figure 1)

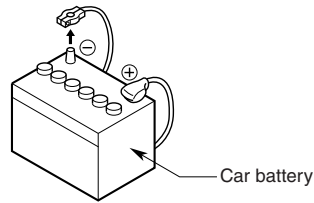

Figure 1

2. PACKAGE CONTENTS

- | | |
|--|--|
| <ol style="list-style-type: none"> ① Main unit ② Manuals
Owner's manual & Installation manual
Warranty card ③ Power supply lead ④ Bag for accessories (No. 1)
Flat head screw (M5 × 8) 4
Sems hexagonal bolt (M5× 8) 5
Electro tap
Machine screw (M4× 3) 4 | <ol style="list-style-type: none"> ⑤ Bag for accessories (No. 2)
Hook plate 2
Cord clamp
Rubber cap
Special screw ⑥ Universal mounting bracket ⑦ Remote control unit ⑧ Battery
(for remote control unit) ⑨ Outer Escutcheon ⑩ DCP Case |
|--|--|

3. GENERAL CAUTIONS

1. Do not open the case. There are no user serviceable parts inside. If you drop anything into the unit during installation, consult your dealer or an authorized CLARION service centre.
2. Use a soft, dry cloth to clean the case. Never use a rough cloth, thinner, benzine, or alcohol, etc. For tough dirt, apply a little cold or warm water to a soft cloth and wipe off the dirt gently.

4. CAUTIONS ON INSTALLATION

1. Prepare all articles necessary for installing the main unit before starting.
2. This model is used with the liquid crystal panel slid forwards (shell loading system). On some types of cars, the liquid crystal panel may touch the dashboard or shift lever, in which case it cannot be installed. Check that the set will not hamper operation of the shift lever before choosing the place of installation. (Figure 2)
5. Use the enclosed screws for installation. Using other screws can cause damage. (Figure 4)

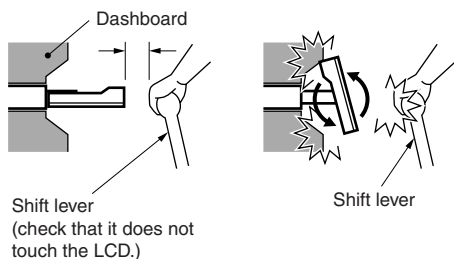

Figure 2

3. Install the unit within 30° of the horizontal plane. (Figure 3)

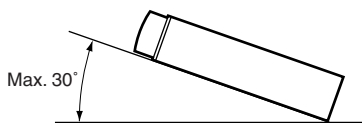

Figure 3

4. If you have to do any work on the car body, such as drilling holes, consult your car dealer beforehand.

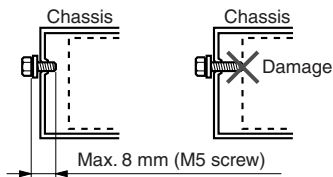

Figure 4

6. The source unit has mounting screw holes for NISSAN (N marks) and TOYOTA (T marks) vehicles.

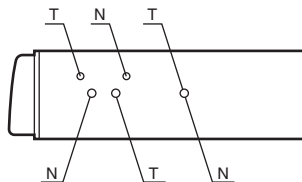

Figure 5

5. INSTALLING THE MAIN UNIT

■ Universal Mount

1. Place the universal mounting bracket into the instrument panel, use a screwdriver to bend each stopper of the universal mounting bracket inward, then secure the stopper as shown in Figure 6.
2. Wire as shown in Section 8.
3. Insert the main unit into the universal mounting bracket until it locks.
4. Mount the outer escutcheon so that all the hooks are locked.

Notes:

- 1) Some car models require special mounting kits for proper installation. Consult your Clarion dealer for details.
- 2) Fasten the front stopper securely to prevent the main unit from coming loose.

• Console opening dimensions

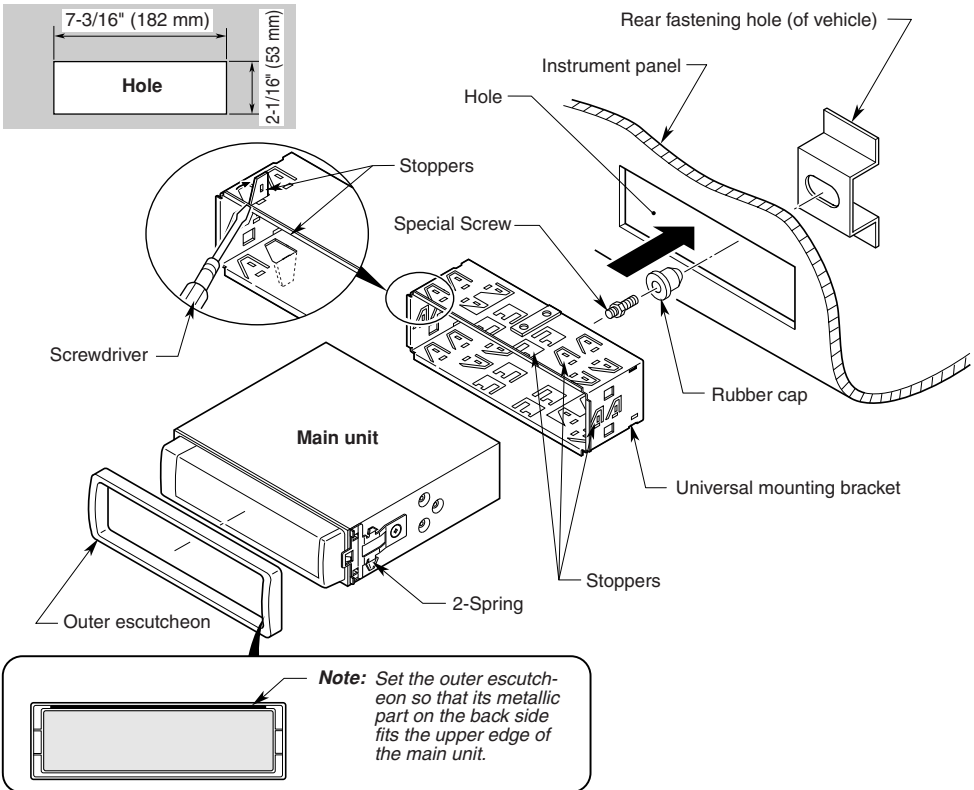
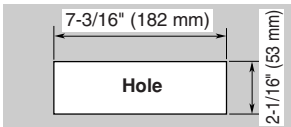

Figure 6

■ Fixed Mount (TOYOTA, NISSAN and other ISO/DIN equipped vehicles)

This unit is designed for fixed installation in the dashboard.

If the vehicle is equipped with a factory-installed radio, install the main unit with the parts and screws marked (*). (Figure 8)

If the vehicle is not equipped with a factory-installed radio, obtain an installation kit to install the main unit in the following procedure.

1. Remove the screws from both side of the main unit. Then, at either side, lift the leaf spring until the engaging claws are released from the holes, and slide the spring to the direction of arrow to remove it. Repeat the same for the other side to remove the springs from the both sides. (Figure 7)
2. Secure the mounting brackets to the chassis as shown in Figure 8. Holes are pre-tapped for TOYOTA and NISSAN vehicles; modification, such as drilling new holes, of the mounting brackets may be required for other models.
3. Wire as shown in Section 8.
4. Secure the unit in the dashboard, and then reassemble the dashboard and the centre panel.

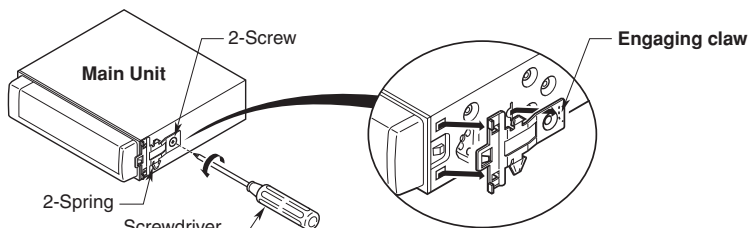

Figure 7

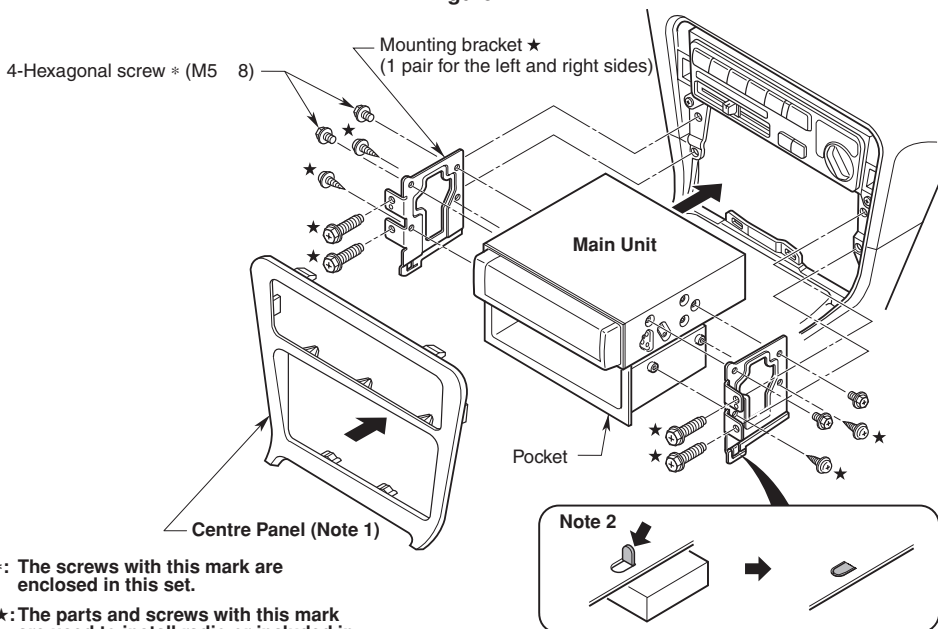

Figure 8

*: The screws with this mark are enclosed in this set.

★: The parts and screws with this mark are used to install radio or included in the installation kit.

Note 1: In some cases, the centre panel may require some modification (trimming, filling, etc.).

Note 2: If a hook on the installation bracket interferes with the unit, bend and flatten it with a nipper or a similar tool.

6. REMOVING THE MAIN UNIT

1. When the rear of the main unit has been secured with the method shown in Figure 6 unfasten the special screw.
2. Remove the outer escutcheon.
3. Insert the hook plate between the spring and the universal mounting bracket, fit tab **B** of the spring into hole **A** of the hook plate, then

pull the main unit out by the hook plate.
(Insert both the right and left edges of the hook plate.) (Figure 9)

Note: Keep the hook plate. You cannot remove the main unit without disengaging the hook plate.

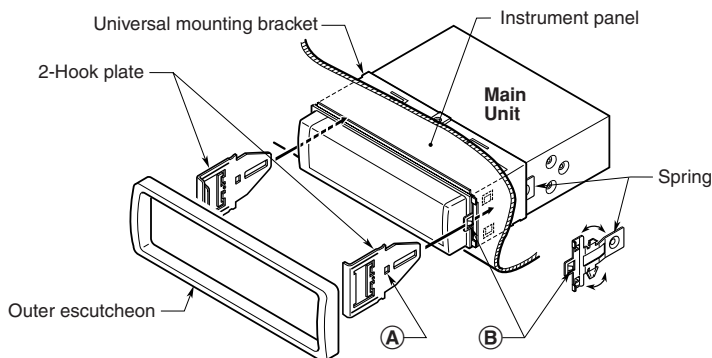

Figure 9

7. CAUTIONS ON WIRING

1. Be sure to turn the power off before wiring.
2. Be particularly careful where you route the wires.
Keep them well away from the engine, and exhaust pipe, etc. Heat may damage the wires.
3. If the fuse should blow, check to see if the wiring is correct.

If it is, replace the fuse with a new one with the same amperage rating as the original (15A FUSE).

4. To replace the fuse, remove the old fuse of the power supply lead and insert the new one. (Figure10)

Note: There are various types of fuse holder. Do not let the battery side touch other metal parts.

CAUTION

After the connection, fix the lead by a clamp or insulation tape for protection.

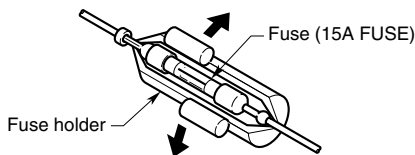
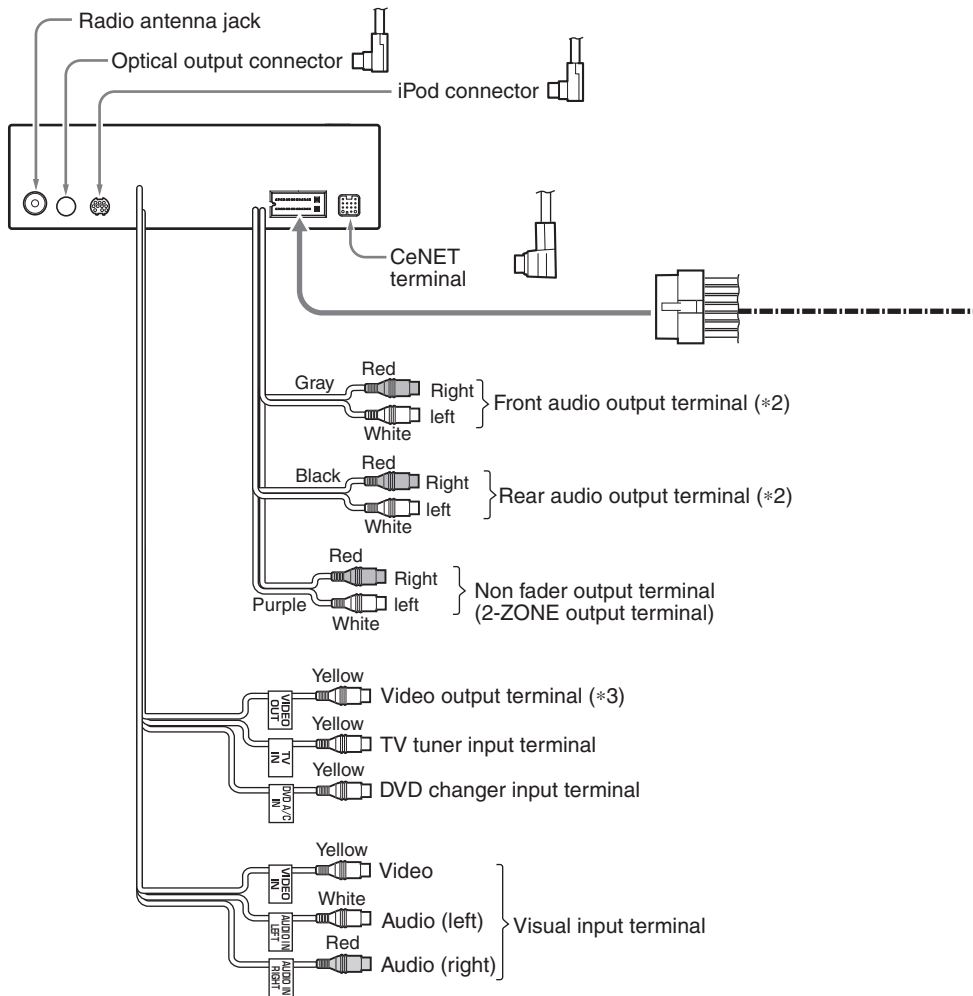

Figure 10

8. WIRE CONNECTION



*1: Connecting the PHONE MUTE Terminal

The lead included with the unit must be connected to the specified position of the vehicle's connector in order to use the **"triggered audio mute for cellular telephones"** function.

Note : Before making any installation, disconnect the car battery – (negative) cable.

*2: Connect to a separately sold external amplifier with a separately sold RCA cord (L, R).

*3: Connect to a Rear View Monitor (sold separately) for the rear seat.

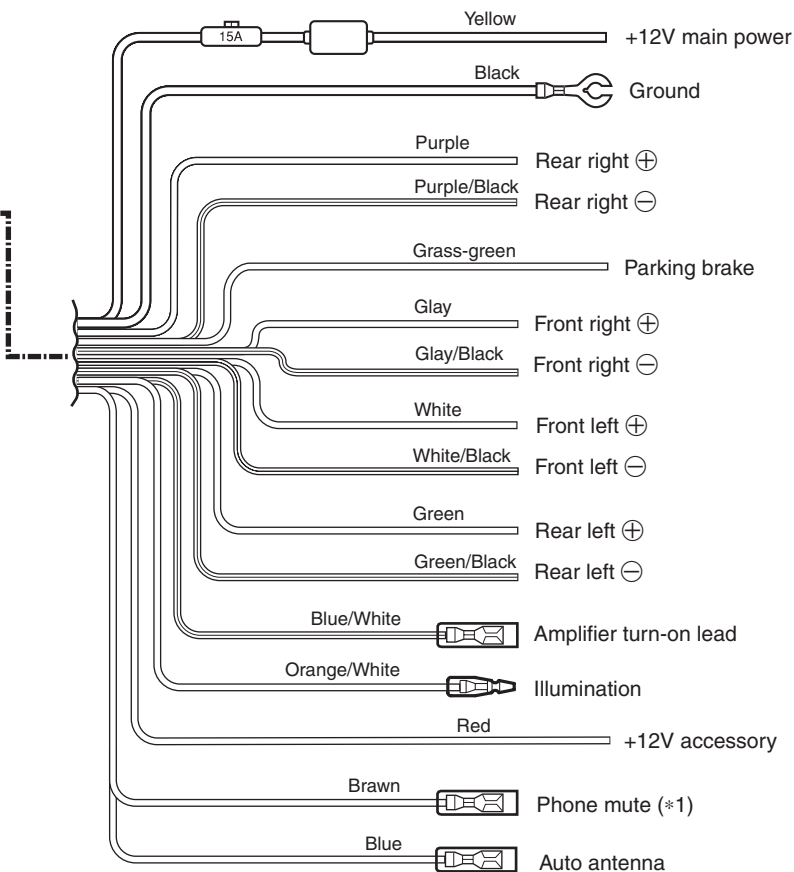

■ Connecting the Accessories

• Connection to the external amplifier

The external amplifier can be connected unless the 5.1ch Surround Decoder is connected. For detailed information, refer to the instruction manual of the 5.1ch Surround Decoder.

• Connection to the CCD camera for vehicle

The CCD camera for vehicle can be connected to CCD terminal on the tuner amp unit. For detailed information, refer to the instruction sheet or manual for the CCD camera.

Notes:

- A power supply box (sold separately) is required for connection of the main unit and the CCD camera.
 - The power supply box for camera CAA147 cannot be used. Please use the CAA188 instead.
- If the specified lead of the cellular phone is connected to the phone mute lead of the source unit, the audio mute is available when the cellular telephone is used.

• SIRIUS Satellite Radio

When the SIRIUS is to be connected, use the CeNET connector. For detailed information, refer to the instruction manual of the SIRIUS.

• TV Tuner

When the TV TUNER is to be connected, connect the CeNET connector and RCA PIN (yellow). For detailed information, refer to the instruction manual of the TV TUNER.

■ Connecting the parking brake lead

Connect the lead to parking brake lamp earth in the meter panel.

Notes:

- Connecting the parking brake lead to lamp earth allows you to watch TV/VTR/DVD video/video CD when the parking brake is engaged.
- When the parking brake lead is not connected, the monitor will stay off.

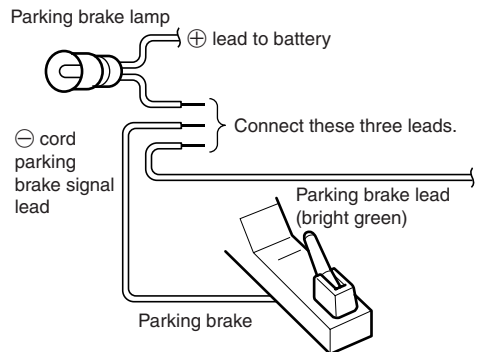

9. SAMPLE SYSTEMS

■ Sample System 1

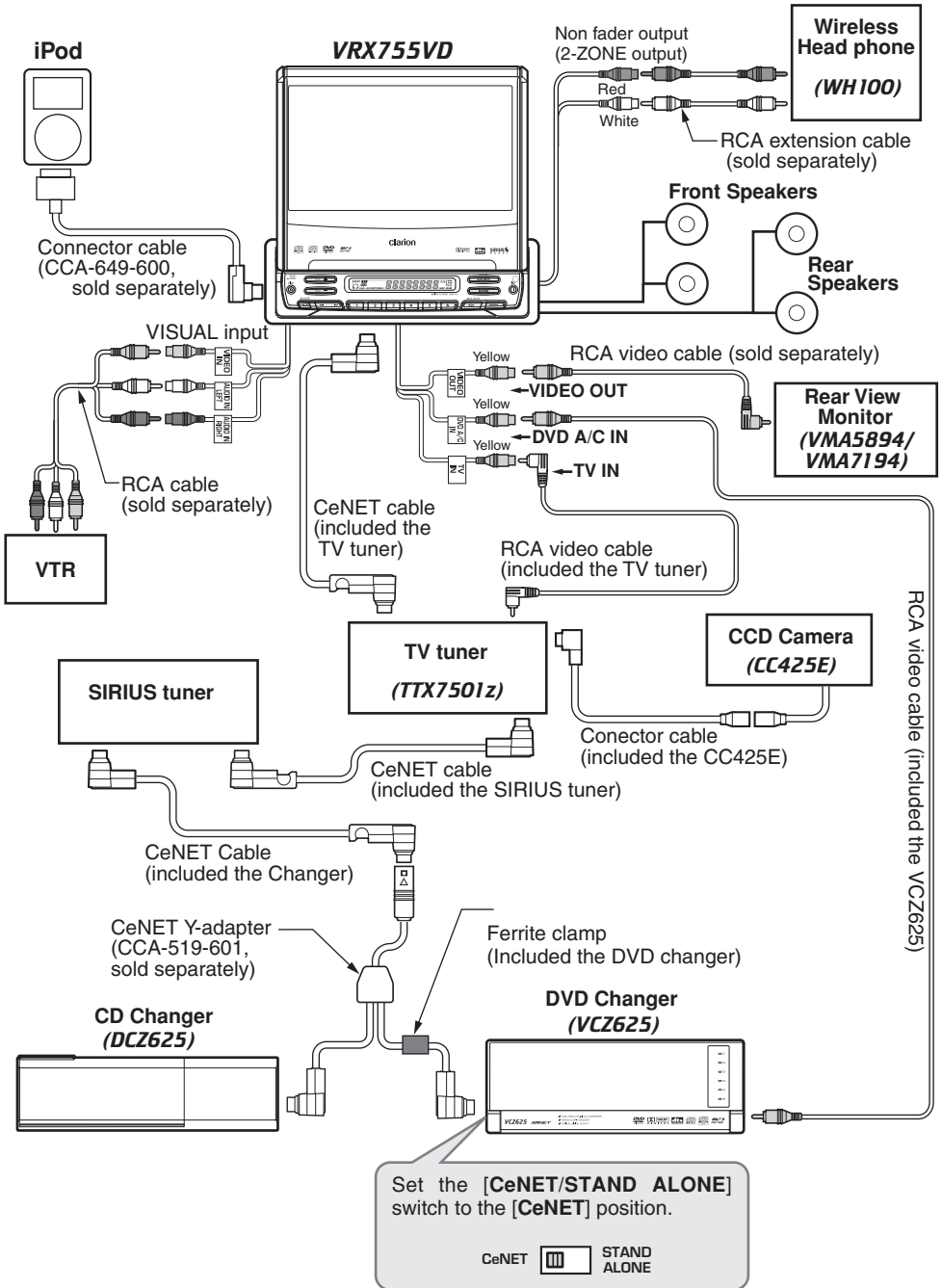

■ Sample System 2

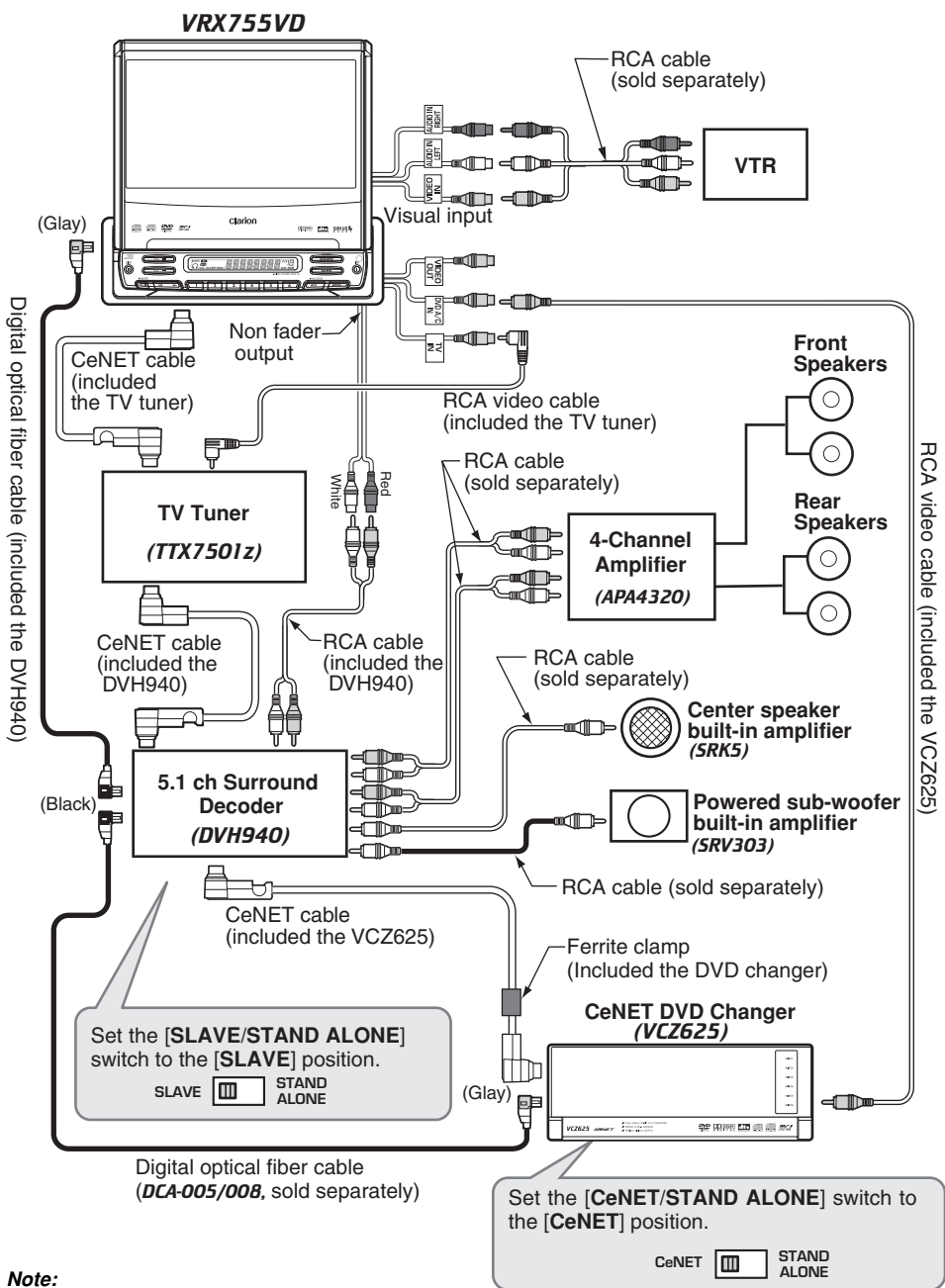

Note:

- When the DVD changer (VCZ625) is connected via optical cable, no sound will be output if AUDIO OUT is switched to ANALOG on the changer's "GENERAL SETUP" menu.